

# **GUIDELINES FOR R.C. WATER TOWERS UPTO 1000 KL CAPACITY**

## **PREFACE**

As seen from past records, many reinforced concrete elevated water tanks were collapsed or highly damaged during sever earthquakes, occurring all over the world. General observations point out the reasons related to the failures mainly of the supporting system, whether RC frame or the shell type towers. Thus, the supporting tower system of the elevated tanks has more critical importance in the Earthquake stability than the structural shape of the tanks. Most of the damages observed during the seismic events arise due improper / unsuitable design of supporting system, improper arrangement of structural elements, improper detailing of reinforcing steel and mistakes during construction of the supporting system.

A review of literature shows the considerable changes in the seismic design practices of elevated tanks. IS: 1893 (Part 2) 2007 has incorporated various modifications to ensure safe earthquake resistant design of water towers in various seismic zones of India.

The Public Health Engineering Department, Government of Bihar has a huge program of construction of Water Towers. It was considered necessary to prepare a guideline which may provide safety considerations and higher quality for Seismic Design and Construction of Water Towers in Bihar.

This Guideline is divided into two parts. Part 1 considers Earthquake Design aspects including elements of seismic analysis, other design considerations, aesthetics, quality control in design and reinforcement detailing in various members of Intze Type RCC water tower. Part 1 covers elevated water tanks of RCC supported on staging with capacity less than or equal to 1000 kL and also for steel water towers with capacity of 200 kL or less.

Part 2 specifies various Indian Standards to ensure appropriate exploration of sub-soil; defects in concrete and RCC construction; tests of construction materials; supervision, inspection and their documentations.

Appendix contains a complete set of structural drawings for 225 kL Intze type water tower, having staging height of 18 meter, to be constructed in seismic zone IV.

Prof. A. S. Arya  
Member BSDMA

B. K. Mishra  
Senior Advsor (Tech), BSDMA

# GUIDELINES FOR R.C. WATER TOWERS UPTO 1000 kL CAPACITY

## INDEX

|  |  |     |     |     |     | Page No. |
|--|--|-----|-----|-----|-----|----------|
| <b>Part- 1 EARTHQUAKE RESISTANT DESIGN</b>     |  |     |     |     |     |          |
| 1  | INTRODUCTION                               | --- | --- | --- | --- | 1        |
| 2  | OBJECTIVE AND SCOPE                        | --- | --- | --- | --- | 1        |
| 3  | NOTATION                                   | --- | --- | --- | --- | 2        |
| 4  | REFERENCES                                 | --- | --- | --- | --- | 2        |
| 5  | ELEMENTS OF SEISMIC ANALYSIS               | --- | --- | --- | --- | 3        |
| 6  | OTHER DESIGN CONSIDERATIONS                | --- | --- | --- | --- | 5        |
| 7  | AESTHETICS                                 | --- | --- | --- | --- | 6        |
| 8  | QUALITY CONTROL IN DESIGN                  | --- | --- | --- | --- | 6        |
| 9  | MISCELLANEOUS                              | --- | --- | --- | --- | 7        |
| 10   | REINFORCEMENT DETAILING IN RCC WATER TOWER | --- | --- | --- | --- | 8        |
| <b>Part- 2 CONSTRUCTION CONTROL PROVISIONS</b> |  |     |     |     |     |          |
| 1  | GENERAL                                    | --- | --- | --- | --- | 19       |
| 2  | FOUNDATION                                 | --- | --- | --- | --- | 19       |
| 3  | DEFECTS IN CONCRETE                        | --- | --- | --- | --- | 20       |
| 4  | EXECUTION OF WORK                          | --- | --- | --- | --- | 21       |
| 5  | TESTS OF CONSTRUCTION MATERIALS            | --- | --- | --- | --- | 25       |
| 6  | IMPORTANT BIS CODES                        | --- | --- | --- | --- | 27       |
| 7  | SUPERVISION, INSPECTION AND DOCUMENTATION  | --- | --- | --- | --- | 27       |
| <b>APPENDIX : DRAWINGS</b>                     |  |     |     |     |     |          |
|  | S1 : GENERAL OUTLINE DRAWING               | --- | --- | --- | --- | 32       |
|  | S2 : GENERAL PLAN AND NOTES                | --- | --- | --- | --- | 33       |
|  | S3 : FOUNDATION DETAILS                    | --- | --- | --- | --- | 34       |
|  | S4 : TIE BEAM, LANDINGS, LADDER            | --- | --- | --- | --- | 35       |
|  | S5 : COLUMN, BRACING AND OFFICE ROOM       | --- | --- | --- | --- | 36       |
|  | S6 : HALF SECTION OF WATER TANK            | --- | --- | --- | --- | 37       |
|  | S7 : BOTTOM DOME DETAILS                   | --- | --- | --- | --- | 38       |
|  | S8 : CYLINDRICAL WALL DETAILS              | --- | --- | --- | --- | 39       |
|  | S8 : TOP ROOF DOME & VENTILATION           | --- | --- | --- | --- | 40       |

# GUIDELINES FOR R.C. WATER TOWERS UPTO 1000 KL CAPACITY

## Part- 1 EARTHQUAKE RESISTANT DESIGN\*

### 1 INTRODUCTION

According to IS:1893 – 2002, eight districts (Sitamarhi, Madhubani, Darbhanga, Supaul, Saharsa, Madhepura, Araria and Kishanganj) fall in severely damaging Seismic Zone V, while, 24 districts of middle Bihar fall in very damaging Seismic Zone IV and rest six district on southern border of Bihar fall in damaging Seismic Zone III. A large number of Water Towers have fallen partially or fully, during Bhuj Earthquake 2001 of magnitude 7.7 on Richter scale. The 1934 Bihar – Nepal Earthquake also caused damages and even collapse of a number of water towers in Bihar.

The Public Health Engineering Department, Government of Bihar has a huge program of construction of Water Towers to provide piped water supply to the villages of Bihar. In view of Giant Earthquake of 1934, which may repeat itself anytime in future, it was considered necessary to provide safety considerations and higher quality for Seismic Design and Construction of Water Towers in Bihar.

This Guideline is divided into two parts. Part 1 considers Earthquake Design aspects including Detailing of Reinforcement in various members. The Design aspect covers Earthquake Resistant Design of Water Tower of RCC type for a capacity of 1000 kL and Steel Tank of 2000 kL. The Detailing of Reinforcement is described for the Intze Type Tank which is being constructed in the most cases by the PHED. Part 2 specifies various Indian Standards to ensure appropriate Exploration of Sub-soil, RCC Construction, Tests of Materials, Supervision, Inspection and their Documentations. Appendix contains sample structural drawings for an Intze Type Water Tower.

### 2 OBJECTIVE AND SCOPE

The extract covers elevated water tanks of RCC supported on staging with capacity less than or equal to 1000 kl, also for steel water towers with capacity of 200 kL or less. References are made to the relevant clauses of **IS: 1893 - Part-2** and are shown under bracket within the clauses of this Guideline.

#### 2.1 One Mass Approximation

In the light of the ongoing practice for construction of large number of water tanks, it is considered expedient to permit the option of one mass idealization, in certain cases, as stated here below, in which the *whole water mass is taken as if in impulsive mode*. Sloshing of water is neglected. (**IS: 1893 - Part-2, Clause 5.2**)

2.1.1 Ground supported or elevated liquid retaining RC structure of up to and including 1000 kL capacity, wall of the container if in concrete, can be regarded as rigid. (**IS: 1893 - Part-2, Clause 5.2.1**)

2.1.2 Wall in steel may not be regarded as rigid, hence for design of steel tanks by one mass model, the capacity should not exceed 200 kl and  $h/D$  or  $h/L$  should be 0.4 or higher. (**IS: 1893 - Part-2, Clause 5.2.2**)

2.1.3 For one mass model, water mass in convective mode will not be considered. Total water mass will be assumed in impulsive mode and the impulsive force will be assumed to act at centre of gravity of the whole water mass. (**IS: 1893 - Part-2, Clause 5.2.3**)

2.1.4 The design shall be worked out both when the tank is full and when empty, when empty, the weight  $W$  used in the design shall consist of the dead load of the tank and one-third the weight of the staging lumped at the centre of gravity of the tank. When full, the weight of the fluid contents is to be added to the weight under empty conditions. (**IS: 1893 - Part-2, Clause 5.2.4**)

---

\* An Extract of IS: 1893 - Criteria for Earthquake Resistant Design of Structures: (Part-2) Liquid retaining tanks.

### 3

#### NOTATION

|          |   |
|----------|---|
| $T_e$    | Time period of the empty tank in seconds  |
| $T_f$    | Time period of the full tank in seconds   |
| $m_e$    | Mass of empty container and one-third mass of staging                                 |
| $m_w$    | Mass of water in tank   |
| $k_s$    | Lateral stiffness of staging  |
| $A_h$    | Design horizontal seismic coefficient   |
| $Z$      | Seismic Zone factor   |
| $I$      | Importance factor   |
| $R$      | Response reduction factor   |
| $Sa/g$   | Average response acceleration coefficient   |
| $V_e$    | Base shear in impulsive mode, for tank empty condition                                |
| $V_f$    | Base shear in impulsive mode, for tank full condition                                 |
| $m_e$    | Mass of empty container and one-third mass of staging                                 |
| $m_w$    | Mass of water in the container  |
| $g$      | Acceleration due to gravity, $9.81 \text{ m/sec}^2$                                   |
| $M_e$    | Overtopping moment, at the base of the staging, for tank empty condition              |
| $M_f$    | Overtopping moment, at the base of the staging, for tank full condition               |
| $H$      | Height of cg of $m_w$ above the bottom of tank wall                                   |
| $h$      | Maximum depth of Liquid   |
| $L$      | Inside Length of Rectangular Tank parallel to the direction of seismic force          |
| $h_i$    | Height of impulsive mass above  |
| $h_s$    | Height of staging, from top of footing of staging to the bottom of tank wall          |
| $h_{cg}$ | Height of cg of the empty container of elevated tank, $m_e$ , from the top of footing |

### 4

#### REFERENCES

(a) The following standards contain provisions which, through reference in this text, constitute provisions of this standard.

1. IS - 456:2000, Code of Practice for plain and Reinforced Concrete
2. IS - 1893 (Part-1), Criteria for Earthquake Resistant Design of Structures, Part 1: General Provisions and Buildings
3. IS - 3370:1967, Code of practice for Concrete Structures for the Storage of Liquids
4. IS - 4326:1993, Code of practice for Earthquake Resistant Design and Construction of Buildings
5. IS -11682:1985, Criteria for Design of RCC staging for Overhead Water Tanks
6. IS -13920:1993, Ductile Detailing of Reinforced Concrete Structures Subjected to Seismic Forces – Code of Practice

(b) Papers and Text books:

1. Gokaraju Rangaraju Institute of Engineering and Technology, Report on DESIGN AND ESTIMATION OF INTZE TANK
2. M.K. Sharma, Z. Ahmed, P. Bhardwaj and S. Choudhury on A PARAMETRIC STUDY OF AN INTZE TYPE TANK
3. Dr. B. C. Punamia, Ashok Kumar Jain and Arun Kumar Jain on RCC DESIGNS
4. Department of Civil Engineering, N I T Rourkela on SEISMIC DESIGN OF ELEVATED TANKS

## 5 ELEMENTS OF SEISMIC ANALYSIS

### 5.1 General

Hydrodynamic forces exerted by liquid on tank wall may not be considered in the analysis in addition to hydrostatic forces.

For tank full as well as empty conditions, tank shall be analyzed for all the load combinations as per IS 1893 (Part 1). For load combination with seismic load, the amount of liquid considered in the tank will be normal liquid level under service condition only. **(IS: 1893 - Part-2, Clause 4.1)**

### 5.2 Time Period of Elevated tank **(IS: 1893 - Part-2, Clause 4.3.1.3)**

Time period of the empty and full tank condition tower;  $T_e$  and  $T_f$  in seconds, are given by

$$T_e = 2 \pi \sqrt{m_e / k_s} \quad \text{---} \quad (5.1)$$

$$T_f = 2 \pi \sqrt{(m_e + m_w) / k_s} \quad \text{---} \quad (5.2)$$

Where,

$m_e$  = mass of empty container and one-third mass of staging and

$k_s$  = lateral stiffness of staging

$m_w$  = mass of water in tank

Lateral stiffness of the staging is the horizontal force required to be applied at the center of gravity of the tank to cause a corresponding unit horizontal displacement.

NOTE – The flexibility of bracing beam shall be considered in calculating the lateral stiffness,  $k_s$  of elevated moment resisting frame type tank staging.

### 5.3 Damping

Damping in the impulsive mode shall be taken as 2 percent of the critical for steel tanks and 5 percent of the critical for concrete or masonry tanks.

### 5.4 Design Horizontal Seismic Coefficient **(IS: 1893 - Part-2, Clause 4.5)**

Design horizontal seismic coefficient,  $A_h$  shall be obtained by the following expression,

$$A_h = \frac{Z}{2} \times \frac{I}{R} \times \frac{S_a}{g} \quad \text{---} \quad (5.3)$$

Where,

$Z$  = Zone factor given in Table 1.

$I$  = Importance factor given in Table 2.

$R$  = Response reduction factor given in Table 3.

$S_a/g$  = Average response acceleration coefficient as given by Fig. 1, here and multiplying factors for obtaining values for other damping as given in Table 4, here.

| Table 1 - Zone Factor, $Z$<br>(as per Table 2 and Clause 6.4.2 of IS: 1893, Part-1) |      |          |        |             |
|---|------|----------|--------|-------------|
| Seismic Zone  | II   | III      | IV     | V           |
| Seismic Intensity   | Low  | Moderate | Severe | Very Severe |
| $Z$   | 0.10 | 0.16     | 0.24   | 0.36        |

| Table 2 - Importance Factor, $I$ , as per Table 1 of IS: 1893, Part-2 |  |     |
|---|--|-----|
| Sl.No.  | Type of liquid storage tank  | $I$ |
| i)  | Tanks used for storing drinking water, non-volatile material low inflammable petrochemicals etc, and intended for emergency services such as fire fighting services. Tanks of post earthquake importance | 1.5 |
| ii)   | All other tanks with no risk to life and with negligible consequences to environment, society and economy  | 1.0 |

| Table 3 - Suggested Values of 'R' for Elevated Tanks<br>(as per Table 2A of IS: 1893, Part-2) |   |          |
|---|---|----------|
| Sl. No.   | Type of Elevated Tank   | 'R'      |
| i)  | <b>Tank Supported on Masonry Shaft:<br/>(Not permitted in Zone IV and V)</b>  |          |
|   | a) Masonry Shaft reinforced with horizontal bands<br>b) Masonry Shaft reinforced with horizontal bands and vertical bars  | 2<br>3   |
| ii)   | <b>Tank Supported on RC Shaft</b>   |          |
|   | a) RC Shaft with reinforcement in one curtain (in both directions) at center of shaft thickness   | 2.5      |
|   | b) RC Shaft with reinforcement in two curtains (in both directions)<br>c) RC Shaft with reinforcement in two curtains (in both directions) and with stiffened openings and bracings | 3.5<br>4 |
| iii)  | <b>Tank Supported on RC Frame</b>   |          |
|   | a) Ordinary Moment resisting Frame type staging*<br>b) Special Moment Resisting Frame conforming ductility requirements of IS 13920 – 1993*   | 2.5<br>4 |
| iv)   | <b>Tank supported on Steel Frame</b>  |          |
|   | a) Special moment resistant Frame without diagonal bracing*<br>b) Special moment resistant Frame with diagonal bracing*   | 3.5<br>4 |

\*P-Delta effect to be included in design of staging.

| Table 4 - Multiplying Factors for Obtaining Values for Other Damping<br>(as per Table 3 and Clause 6.4.2 of IS: 1893, Part-1) |      |      |      |      |      |      |      |      |      |
|---|------|------|------|------|------|------|------|------|------|
| Damping Percent   | 0    | 2    | 5    | 7    | 10   | 15   | 20   | 25   | 30   |
| Factors   | 3.20 | 1.40 | 1.00 | 0.90 | 0.80 | 0.70 | 0.60 | 0.55 | 0.50 |

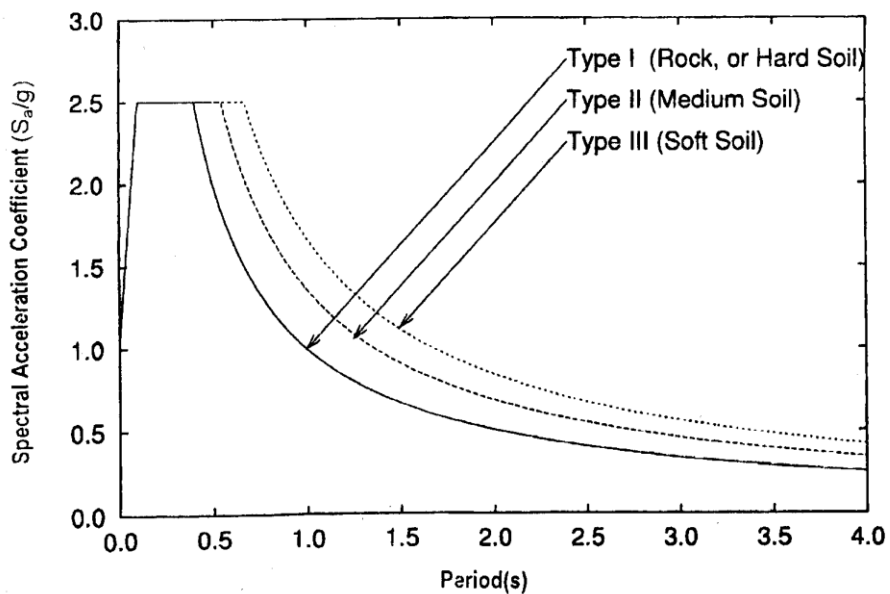

Fig. 1: Response Spectra for Rock and Soil Sites for 5 Percent Damping  
(as per Figure 2 of IS: 1893, Part-1)

## 5.5 Base Shear and moment of Elevated Tank

5.5.1 For elevated tanks, the design shall be worked out for tank empty and tank full conditions.

5.5.2 Base shear in impulsive mode, just above the base of staging (i.e. at the top of footing of staging) is given by, **(IS: 1893 - Part-2, Clause 4.6.2)**

$$V_e = A_h m_e \quad \text{for tank empty condition} \quad \text{--- (5.4)}$$

$$V_f = A_h (m_e + m_w) g \quad \text{for tank full condition} \quad \text{--- (5.5)}$$

Where,

$m_e$  = Mass of empty container and one-third mass of staging

$m_w$  = Mass of water in the container

5.5.3 The Overturning moment, at the base of the staging is given by:

**(IS: 1893 - Part-2, Clause 4.7.2)**

$$M_e = A_h m_e h_{cg} g, \quad \text{for tank empty condition} \quad \text{--- (5.6)}$$

$$M_f = A_h [m_w (h + h_s) + m_e h_{cg}] g, \quad \text{for tank full condition} \quad \text{--- (5.7)}$$

Where,

$h$  = height of cg. of  $m_w$  above the top of the Bottom Ring Beam

$h_s$  = Structural height of staging, measured from top of footing of staging the top of the Bottom Ring Beam, and

$h_{cg}$  = Height of centre of gravity of the empty container of elevated tank,  $m_e$ , measured from the top of footing

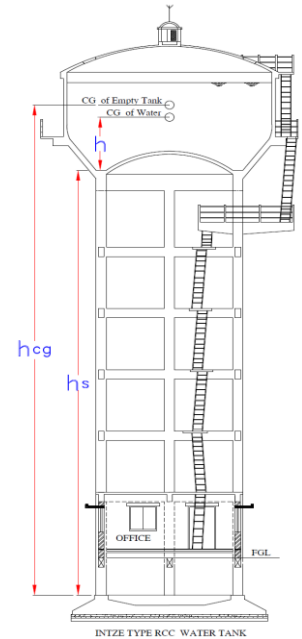

## 5.6 Effect of Vertical Ground Acceleration

**(IS: 1893 - Part-2, Clause 4.10)**

Due to upward vertical ground acceleration, effective weight of liquid increases, this induces additional pressure on tank wall, whose distribution is similar to that of hydrostatic pressure, and should be considered in the design of tank walls.

## 6 OTHER DESIGN CONSIDERATIONS

6.1 For elevated tanks, staging components should be designed for the critical direction of seismic force. Different components of staging may have different critical directions.

Direction of seismic force for design of Bracings

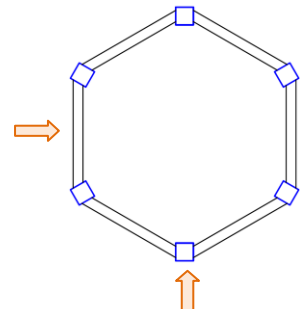

Direction of seismic force for design of Columns

## 6.2 P-Delta Effect

Staging columns and braces (or beams) for the elevated tank shall be designed for P-Delta effect.

**(IS: 1893 - Part-2, Clause 6.5)**

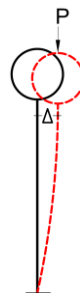

## 6.3 Strong Column – Weak Beam

**(IS: 1893 - Part-2, Clause 8.4)**

For column and beam type of staging of elevated tank, sum of moment of resistance of column at a junction should not be less than 1.1 times the sum of moment of resistance of beams in any one plane taken at a time. This check is to be applied by *limit state method*.

## 7 AESTHETICS (IS: 1893 - Part-2, Clause 7)

Elevated water tanks are prominently in public view and visible from near as well as long distance. They often become landmarks on the landscape. It is therefore important that the shape and form of the container and the supporting structure must receive due attention from the point of aesthetics. Innovations in the shape and form should be encouraged when they improve the ambience and enhance the quality of the environment.

Where unusual shapes and forms for supporting structures are used, the designer may use some discretion in choosing the value of response reduction factor R consistent with expected seismic performances and ductility. It will be incumbent on the designer, however, to justify the choice of R value vis-à-vis the seismic safety.

## 8 QUALITY CONTROL IN DESIGN (IS: 1893 - Part-2, Clause 8)

Quality control in design and constructions are particularly important for elevated tanks in view of several collapses of water tanks **during testing**. It is necessary that quality of materials and construction tolerances are strictly adhered to during construction phase. Some construction tolerances and detailing are listed below. The information given is not exhaustive and designers and construction engineers are expected to have competence to take adequate measures to ensure required structural performance.

NOTE – The design/construction details for reinforced concrete should strictly follow IS 456, IS 3370, and IS 11682. The recommendations are made here to ensure safety under normal as well as service loads.

### 8.1 RC Frame Staging

#### 8.1.1 Columns (IS: 1893 - Part-2, Clause 8.1.1)

- a) Minimum size of column should be 400 mm (diameter and/or side of rectangular column). For tanks having 200 m<sup>3</sup> or less capacity, columns of 300 mm size may be used.
- b) Clear height of column between braces should not be more than ten times the size of column.
- c) Reinforcement detailing including overlaps in longitudinal bars should follow that shown in IS 13920.
- d) During construction and casting of columns, some eccentricity in the verticality of column may develop. Eccentricity up to 20 mm may be allowed in column between two brace levels. Additional moment due to this eccentricity should be considered in the analysis.

#### 8.1.2 Braces (IS: 1893 - Part-2, Clause 8.1.2)

- a) Minimum width of un-flanged brace shall not be less than 1/30<sup>th</sup> of its **clear length** between junctions.
- b) In seismic zones IV and V, use of diagonal bracings in vertical plane shall be encouraged. Information on detailing of RC and steel diagonal bracings is given in IS 11682.

#### 8.1.3 Foundation (IS: 1893 - Part-2, Clause 8.1.3)

For isolated footings, tie beam near top of footing shall be provided as per IS 4326.

### 8.2. RC Shaft Staging

#### 8.2.1 Thickness of Shaft (IS: 1893 - Part-2, Clause 8.2.1)

- i) Minimum thickness of shaft shall be suitable for constructability which depends on height of formwork for one lift of concrete. Minimum thickness of shaft shall be 150 mm for shaft diameter upto 4 m. For larger diameter shafts, following equations shall be used to arrive at minimum thickness.

- a) For shafts with diameter less than 8000 mm.

$$t_{\min} = 150 + (D - 4000)/80 \text{ mm}$$

- b) For shafts with diameter equal to or greater than 8000 mm.

$$t_{\min} = 200 + (D - 8000)/120 \text{ mm}$$



- ii) Additional thickening of shaft and extra vertical and circumferential reinforcement shall be provided at top and bottom level of shaft (i.e. at junctions with foundation and with container). This is required to account for secondary moments and eccentricities. *Additional* vertical and circumferential reinforcement shall be same as that required as per design calculations.

**8.2.2 Reinforcement in Shaft** (IS: 1893 - Part-2, Clause 8.2.2)

- a) Minimum vertical reinforcement shall be 0.25 percent of concrete area. The reinforcement shall be provided in two layers. The minimum diameter of vertical bars shall be 10 mm. Maximum centre-to-centre distance between vertical reinforcement in each layer shall not exceed 300 mm.
- b) Circumferential reinforcement shall not be less than 0.2 percent of concrete area in vertical section. Since reinforcement is provided in two layers, circumferential reinforcement shall be divided equally in two layers. The spacing of circumferential bars in each layer shall not be more than 300 mm or shell thickness whichever is less. Circumferential reinforcement shall be placed nearer the faces of shell.
- c) At horizontal construction joints in shaft, one additional layer of vertical bars projecting on either side of the joint with  $l_d$  anchorage length shall be provided. Continuity of concreting at construction joint shall be done with application of neat cement slurry.
- d) Openings in shaft: Detailing of shaft at the opening shall take into consideration effective continuity of reinforcement at all sides. More information on detailing near openings is given in IS 11682. At vertical edges of door opening stiffeners may be required.

**8.2.3 Isolated Footing** (4326-1993 (Part-1), Clause 5.3.4)

All the individual footings or pile caps where used in Type III soft soils (**Table 3 of IS 1893 :1984**), shall be connected by reinforced concrete ties at least in two directions approximately at right angles to each other. The ties may be placed at or below the plinth level and they may be designed to carry the load of the panel walls also.

**8.2.4 Mat Foundation** (IS: 1893 - Part-2, Clause 8.2.4)

In case of mat foundations, lifting of mat on tension side can be allowed at soil contact. The maximum eccentricity at base may be permitted up to 0.25 times the base diameter provided the maximum compression remains within permissible limits.

**8.3 RC Tank and Shaft** (IS: 1893 - Part-2, Clause 8.3)

- a) In the tank ring beams, reinforcement bars in direct tension shall have lap length twice the development length in tension. The spliced length of the ring beams in tension shall be enclosed in spirals made of bars not less than 6 mm diameter with pitch not more than 100 mm, or enclosed in stirrups of 8 mm diameter with pitch not more than 150 mm, the stirrups shall have  $135^\circ$  hooks bent into the core concrete with minimum 50 mm extension.
- b) In tank wall or shaft, not more than one-third of vertical bars shall be spliced at any section. For circumferential bars, lap length shall be 1.4 times development length in tension; the laps shall be staggered so that not more than one-third the bars shall be spliced at any one section.

**9 MISCELLANEOUS**

**9.1 Piping** (IS: 1893 - Part-2, Clause 6.1)

Piping system connected to tanks should be given consideration of potential vibration and movement at the pipe joints during earthquakes and sufficient flexibility should be introduced by proper detailing of pipe joints to avoid de-function. Piping system and its connection to the tank should be designed to comply with the assumptions made and the likely performance; merely neglecting the weight of piping system may not be adequate in all cases.

The piping system shall be designed so as not to impart significant mechanical loading on tank. Local loads at pipe connections can be considered in the design of the tank. Mechanical devices, which add flexibility to piping such as bellows, expansion joints and other special couplings, may be used in the connections.

**9.2 Staircase design – Provisions of IS 11682 shall be followed for the staircase design. (IS: 1893 - Part-2, Clause 8.5)**

**10 REINFORCEMENT DETAILING IN RCC WATER TOWER**

**10.1 DETAILINGS**

1. FOUNDATION : SOLID / ANNULAR RAFT
2. COLUMN
3. BRACING BEAM
4. OFFICE ROOM : ROOF SLAB
5. LANDING SLAB & BEAM
6. JUNCTION 1
7. BOTTOM DOME
8. JUNCTION 2
9. CYLINDRICAL WALL
10. JUNCTION 3
11. TOP DOME
12. VENTILATION SHAFT

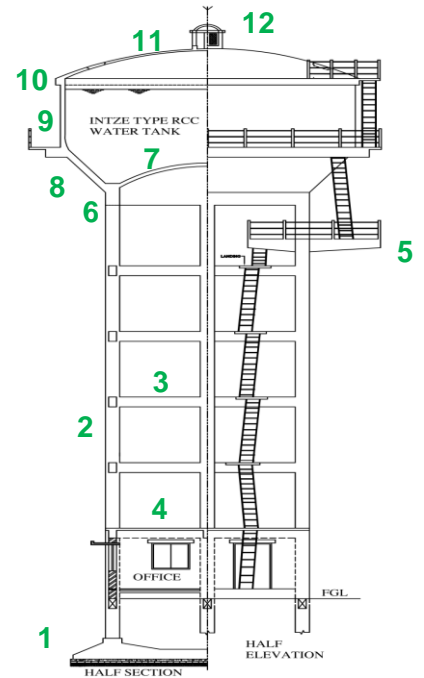

**10.2 FOUNDATION: SOLID RAFT**

**10.2.1 BOTTOM LAYER BARS**

Circumferential bars, Radial bars and bottom square mesh are shown in Plan.

Lap Length of bars =  $47 \times \text{dia of bars}$

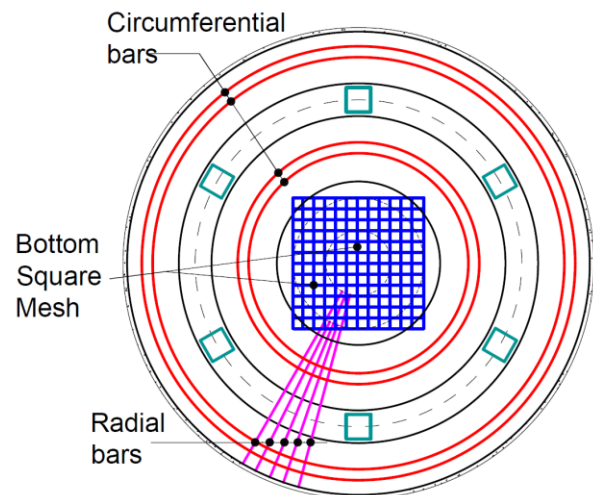

Presented by: Er. Brajesh Kumar Sinha, SDCON, Patna during **Training on quality assurance in construction of RCC water tanks and towers**

### 10.2.2 TOP LAYER BARS

Circumferential bars, Radial bars and top square mesh are shown in Plan.

Lap Length of bars =  $47 \times \text{dia of bars}$

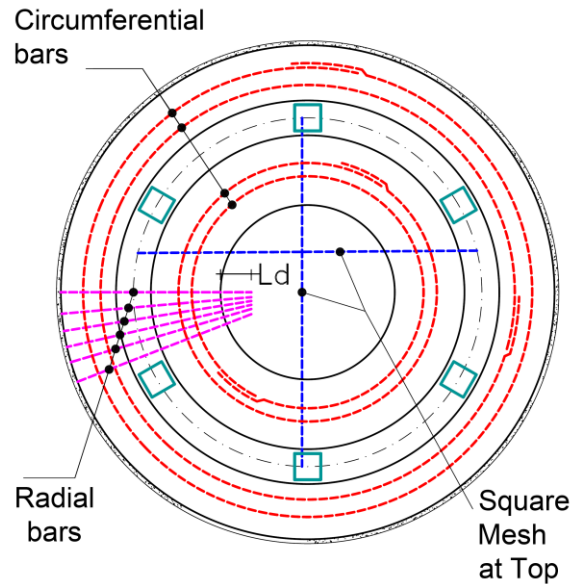

### 10.2.3 SOLID RAFT : SECTION

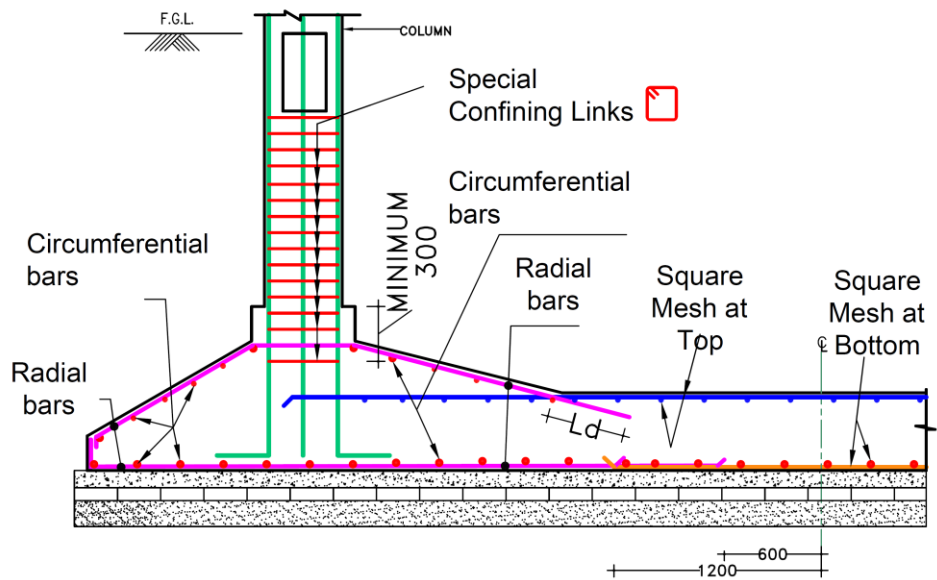

Circumferential bars, Radial bars, Top square mesh, Bottom square mesh, Column Dowels are shown in Section along with anchorage of radial bars equal to a length of  $L_d$ . Where  $L_d = 47 \times \text{dia of bars}$ . Special confining links in columns are also shown.

### 10.3 FOUNDATION: ANNULAR RAFT

#### 10.3.1 BOTTOM LAYER BARS

Circumferential bars and Radial bars are shown in Plan.

Lap Length of bars =  $47 \times \text{dia of bars}$

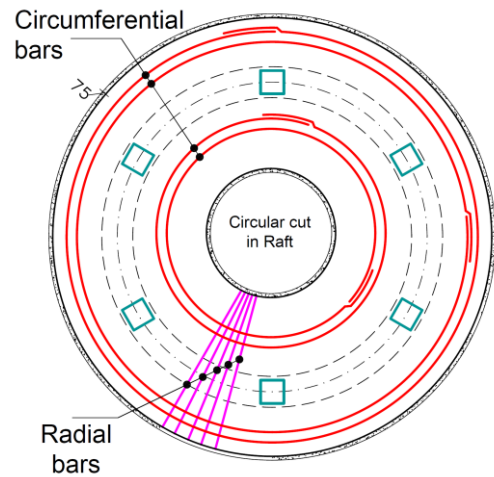

#### 10.3.2 FOUNDATION: ANNULAR RAFT, TOP LAYER BARS

Circumferential bars and Radial bars are shown in Plan.

Lap Length of bars =  $47 \times \text{dia of bars}$

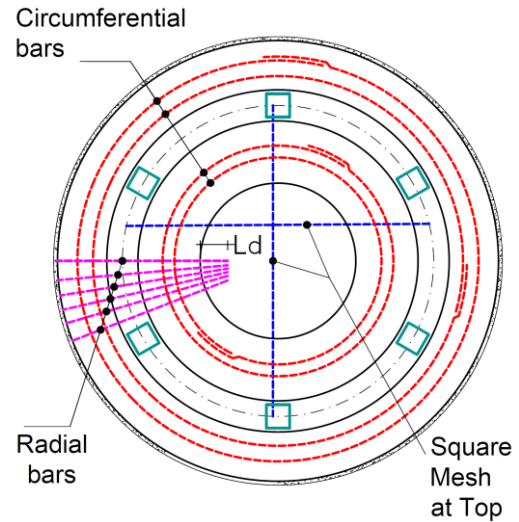

#### 10.3.3 ANNULAR RAFT : SECTION

Circumferential bars, Radial bars, and Column Dowels are shown in Section. Special confining links in columns are also shown.

Lap length of bars =  $47 \times \text{diameter of bar}$ .

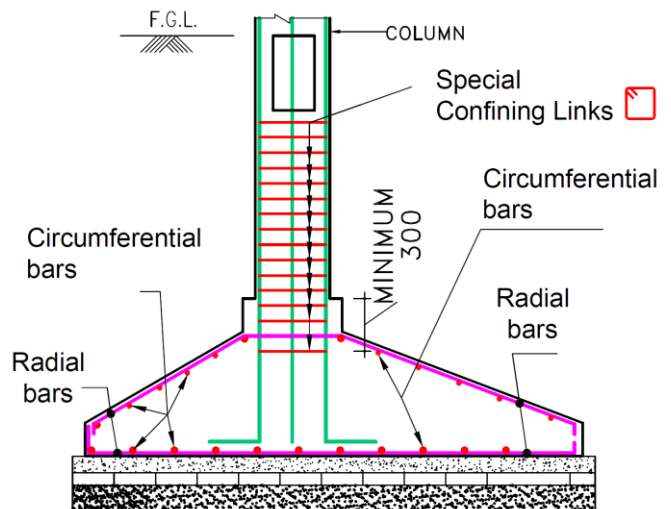

### 10.4 SPECIAL CONFINING LINKS IN STAGING COLUMNS

**Column**

b = lesser dimension  
D = Larger dimension

**Links**

Minimum spacing @ b/2 c/c  
Reduced spacing of special confining links at the joints shown in the figure.

**Lapping of longitudinal bars**

Maximum 50% of longitudinal bars to be lapped at any section

Lapping Zone and Reduced spacing of links in the lapping zone shown in the figure.

Lap length = 40 x bar diameter

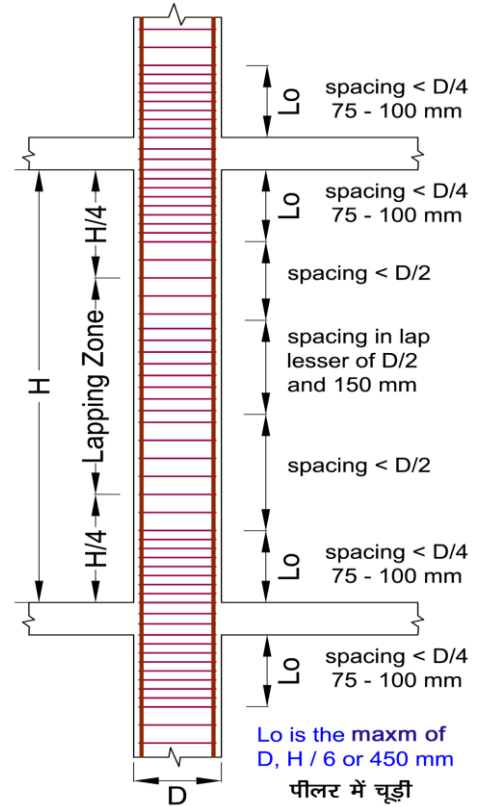

### 10.5 STAGING - BRACING BEAM

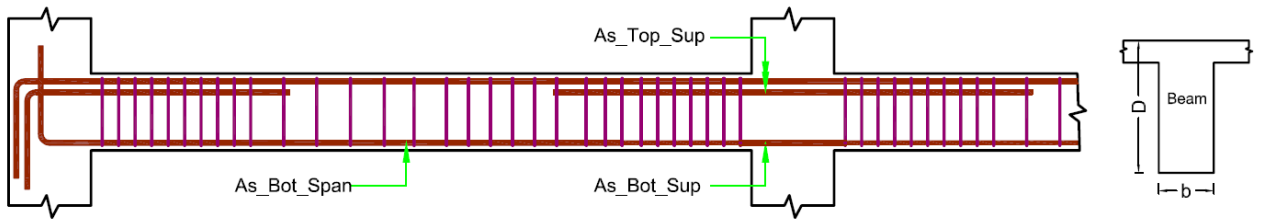

$$As_{Bot\_sup} > 0.5 \times As_{Top\_Sup}$$

$$As_{Bot\_Span} > 0.25 \times As_{Top\_Sup}$$

Minimum Steel =  $0.24 (\sqrt{f_{ck}} / f_y) bD$   
Maximum Steel =  $0.025 bD$

**LONGITUDINAL REINFORCEMENT IN BEAMS**

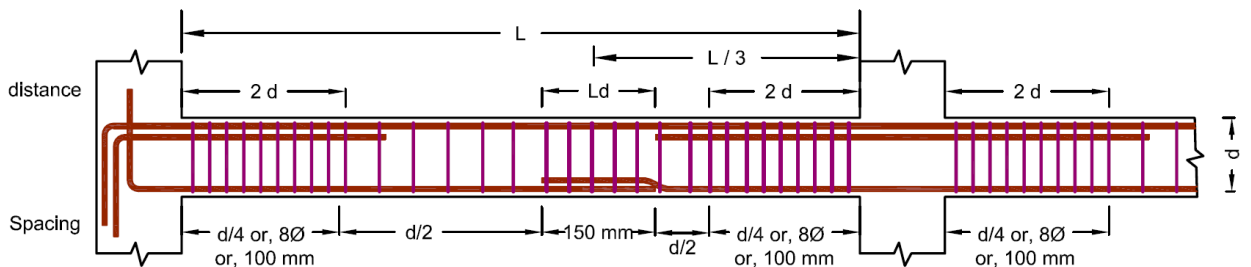

**MAXIMUM SPACING OF VERTICAL STIRRUPS IN BEAMS**

**10.6 OFFICE ROOM: ROOF SLAB**

Location of Roof beam, Slab reinforcement and Reinforcement around the edge of cutout are shown in plan.

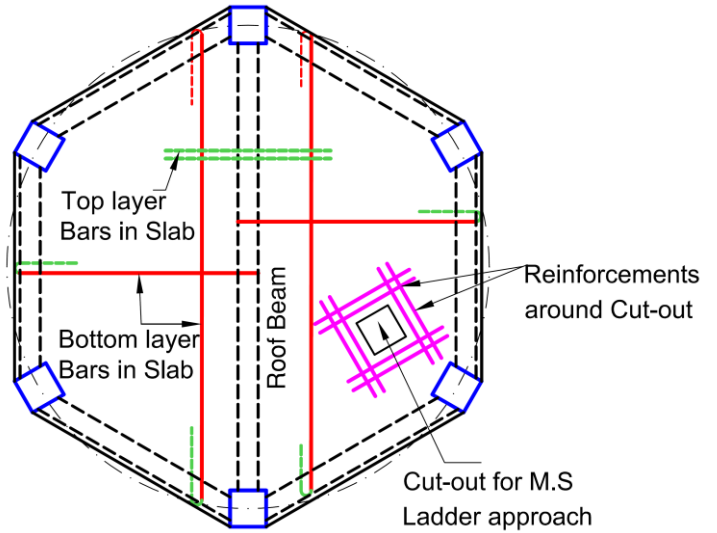

**10.7 CANTILEVER LANDING SLAB**

600 mm wide landing slab is shown in Plan. Slab is projected from the bracing beam.

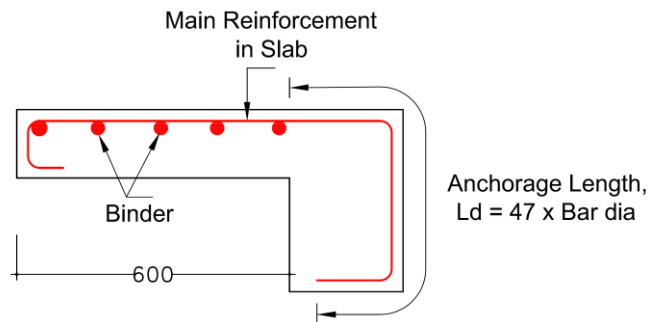
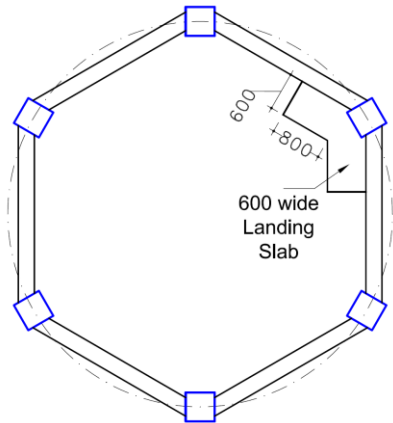

Details of reinforcement for cantilever slab are shown in Section.

**10.8 LARGER LANDING BELOW TANK**

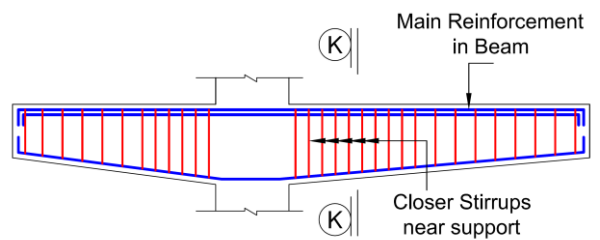
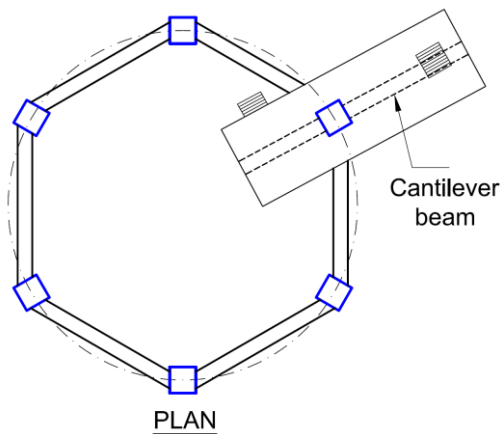

**SECTION THROUGH CANTILEVER BEAM**

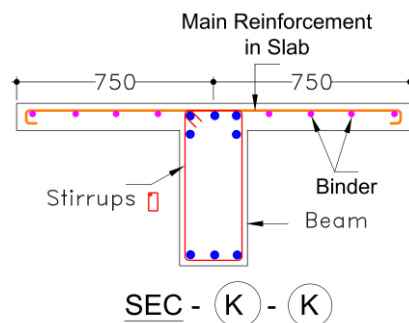

### 10.9 JUNCTION WITH BOTTOM RING BEAM

Radial bars from the Bottom dome and the Conical wall enter straight into the Bottom ring beam and these bars are anchored into the Bottom ring beam by an anchorage length =  $L_d$ , where,  $L_d$  is equal to  $47 \times$  diameter of bar.  
Ties are shown in the Conical wall. Circumferential bars and stirrups of bottom ring beam are also shown.

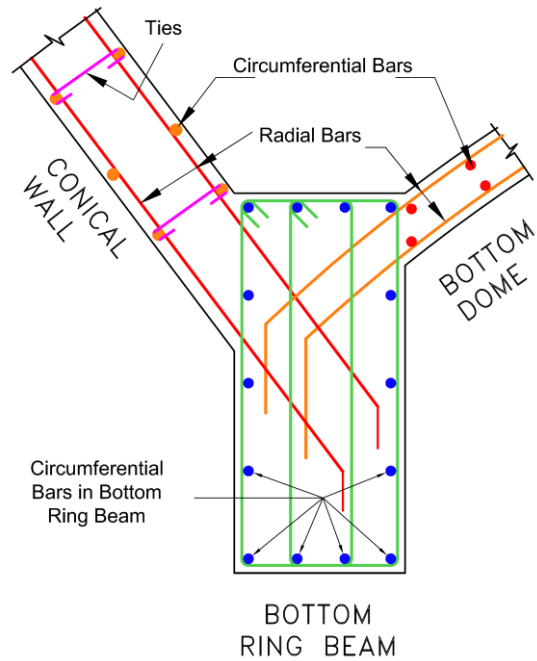

### 10.10 BOTTOM DOME

#### 10.10.1 BOTTOM DOME : BOTTOM LAYER BARS

The reinforcements consisting of Circumferential bars, Radial bars and central Square mesh are shown in plan.

Lapping of Circumferential bars are also shown. Lap length =  $47 \times$  diameter of bar.

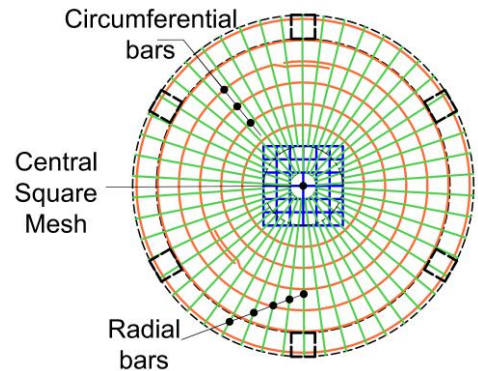

#### 10.10.2 BOTTOM DOME : TOP LAYER BARS

The reinforcements consisting of Circumferential bars, Radial bars, Extra Radial bars and central Square mesh are shown in plan.

Lap length =  $47 \times$  diameter of bar.

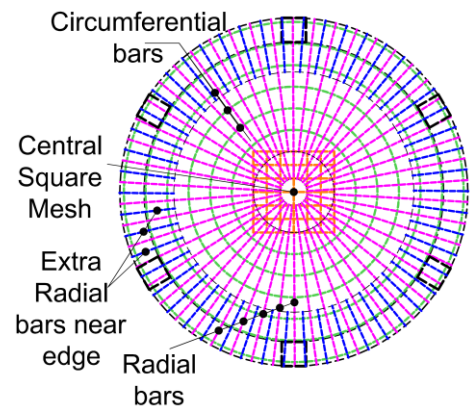

10.11 HALF - CROSS SECTIONAL VIEW OF TANK

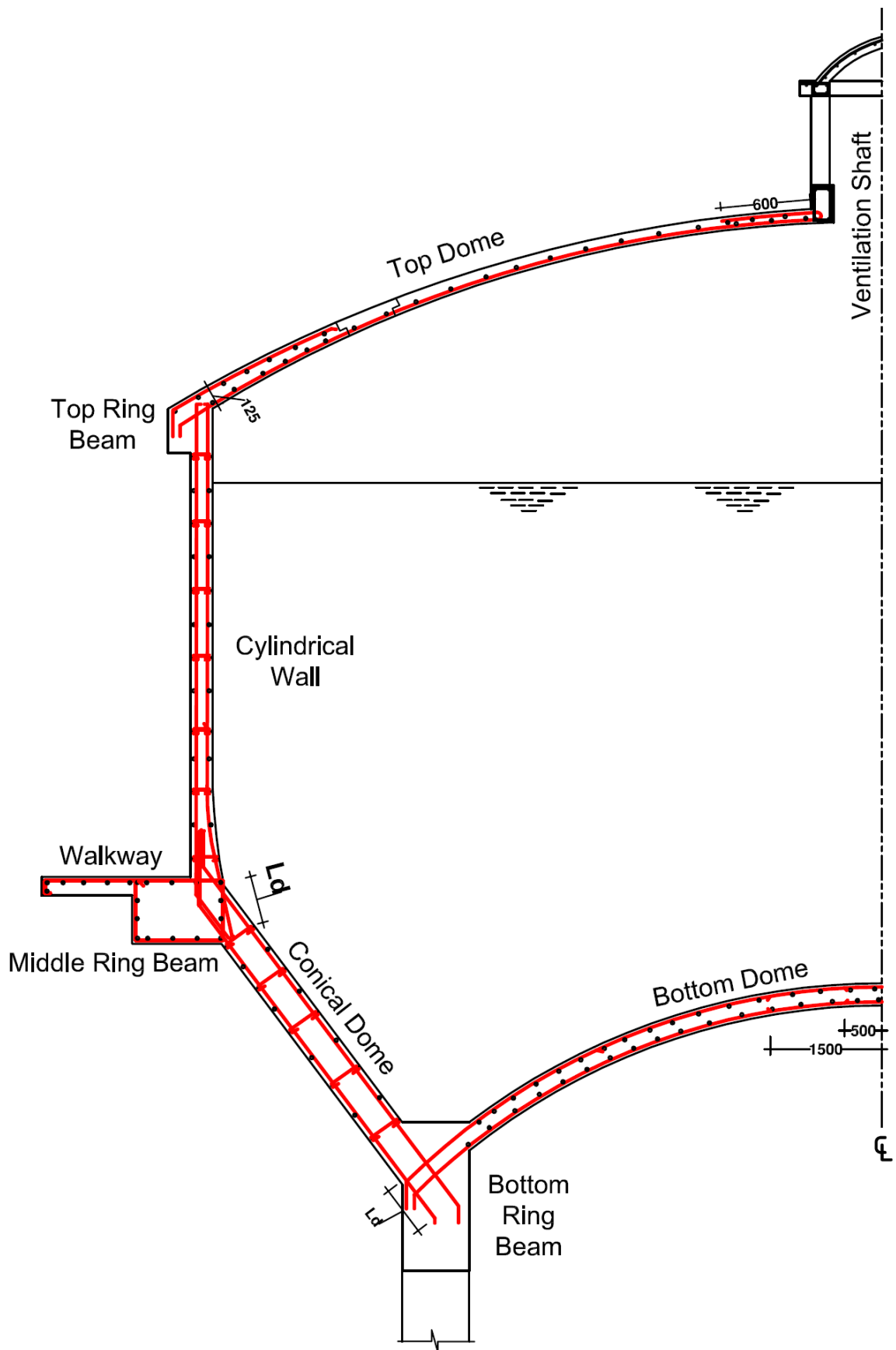



## 10.12 CYLINDRICAL WALL

### 10.12.1 CYLINDRICAL WALL IN PLAN

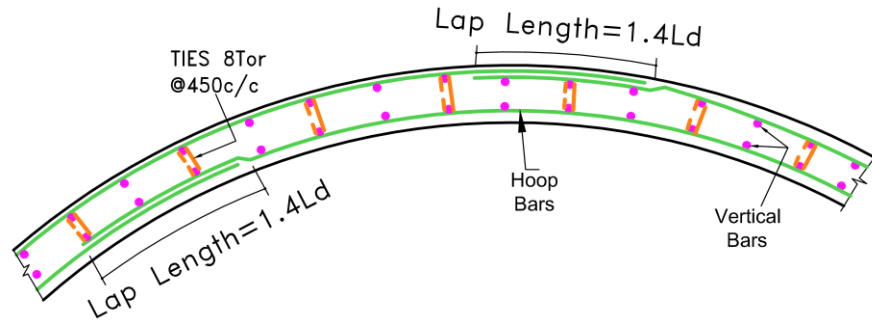

The reinforcements in cylindrical wall consisting of Hoop bars, vertical bars and ties are shown in the Sectional Plan.  
Lap length of hoop bars shall be  $1,4 \times L_d$ ,

### 10.12.2 CYLINDRICAL WALL IN ELEVATION

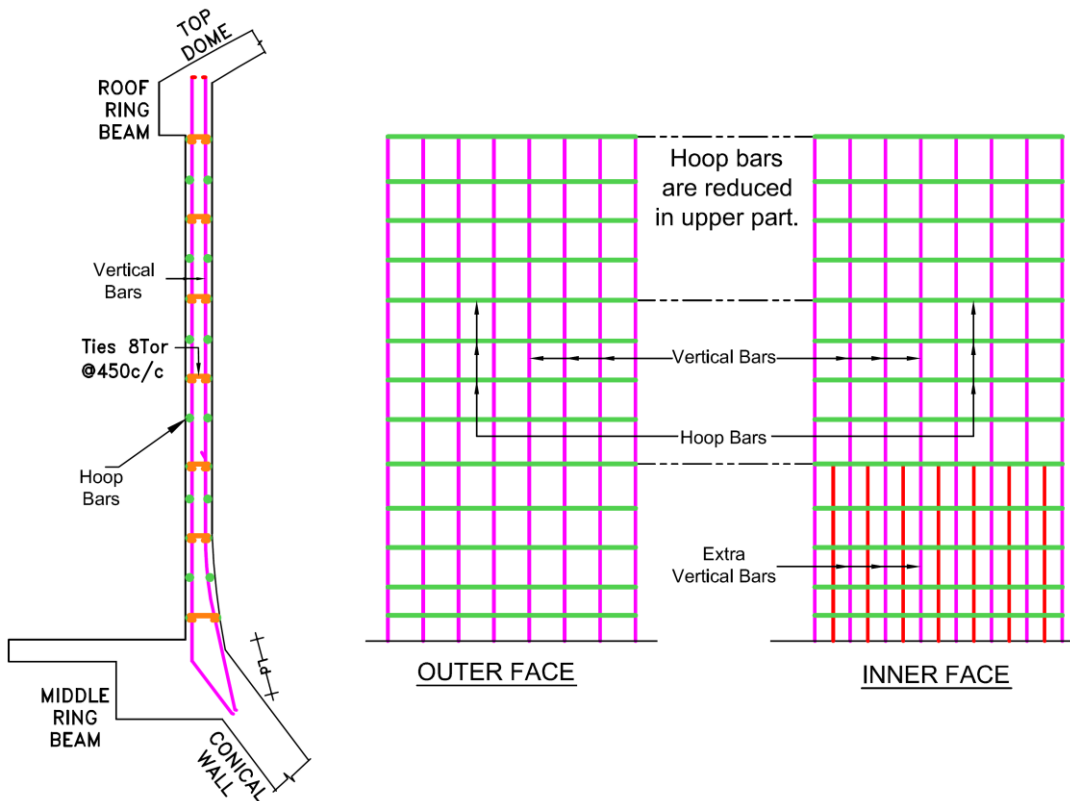

The reinforcements in cylindrical wall consisting of Hoop bars, Vertical bars, Extra Vertical bars and ties are shown in the Sectional Elevation. Reinforcements on inner and outer faces are also shown on Elevations.

### 10.12.3 LAPPING OF VERTICAL BARS

Lap length of vertical bars shall be equal to  $L_d$ , where  $L_d = 47 \times \text{diameter of bar}$ .

Maximum 1/3rd bars shall be spliced at any section. (Staggered splicing)

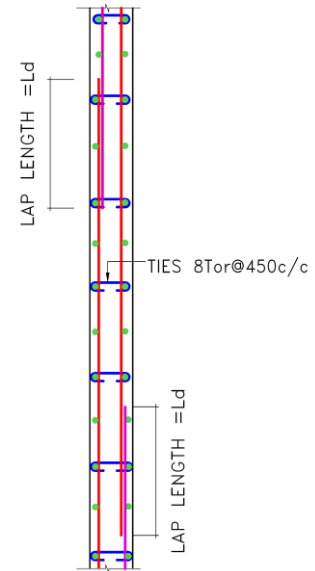

### 10.13 MIDDLE RING BEAM

#### 10.13.1 LAPPING OF CIRCUMFERENTIAL BARS

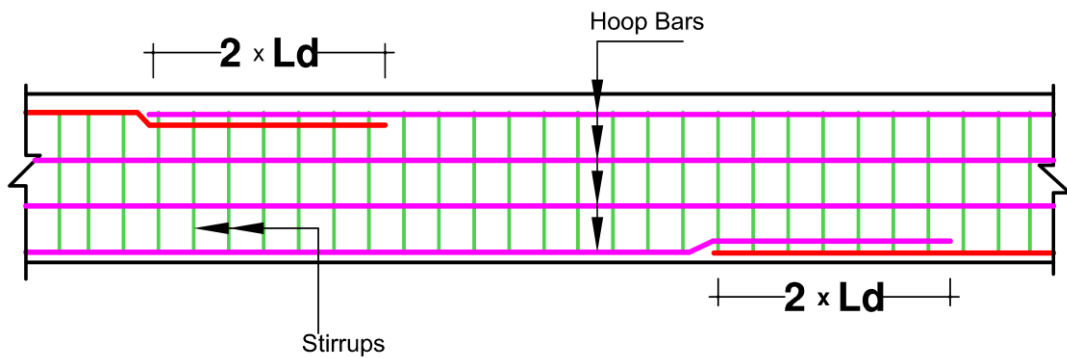

Lap =  $2 \times L_d$ , where,  $L_d = 47 \times \text{diameter of bar}$ .

#### 10.13.2 JUNCTION WITH MEMBERS

Ties are shown in the Cylindrical wall. Circumferential bars and stirrups of the Middle ring beam are shown. Construction joints are also seen.

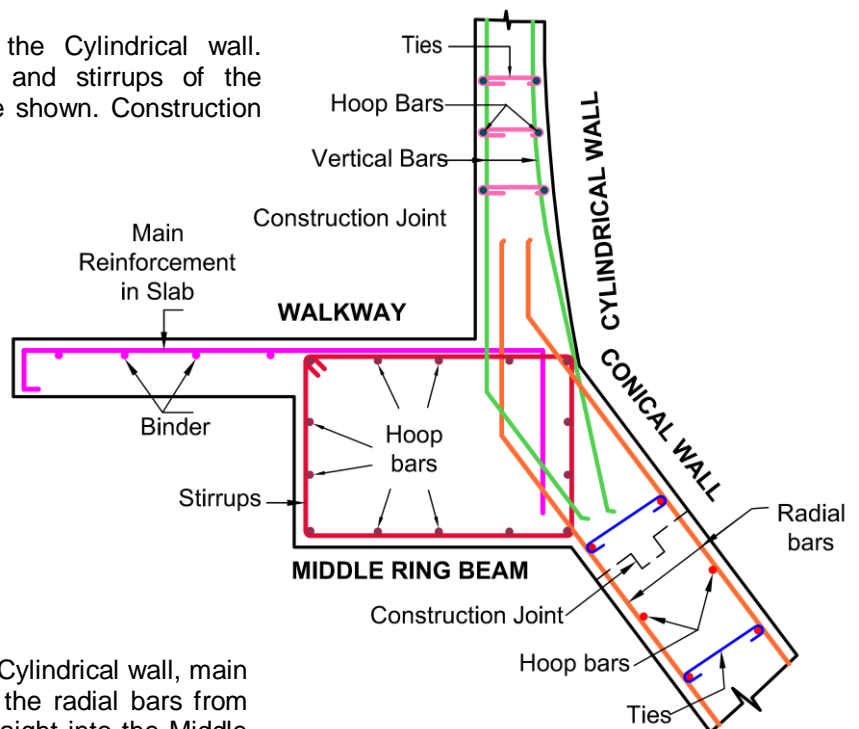

Vertical bars from the Cylindrical wall, main bars of Walkway and the radial bars from Conical wall enters straight into the Middle ring beam and these bars are anchored by anchorage length =  $L_d$ . Where,  $L_d$  is equal to  $47 \times \text{diameter of bar}$ .

**10.14 ROOF RING BEAM**

**10.14.1 LAPPING OF CIRCUMFERENTIAL BARS**

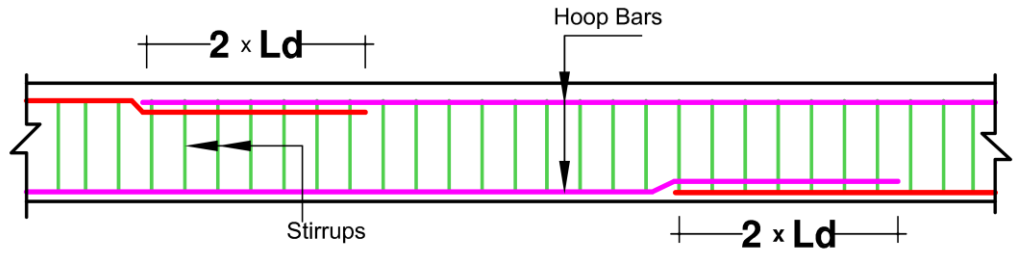

Lap = 2 x Ld, where, Ld = 47 x diameter of bar.

**10.14.2 JUNCTION WITH ROOF RING BEAM**

Radial bars from the Top dome, main bars of the projected slab and the Vertical bars from Conical wall enters into the Roof ring beam and these bars are anchored by anchorage length = Ld. Where, Ld is equal to 47 x diameter of bar. Ties are shown in the Cylindrical wall. Circumferential bars and stirrups of the Roof ring beam are shown.

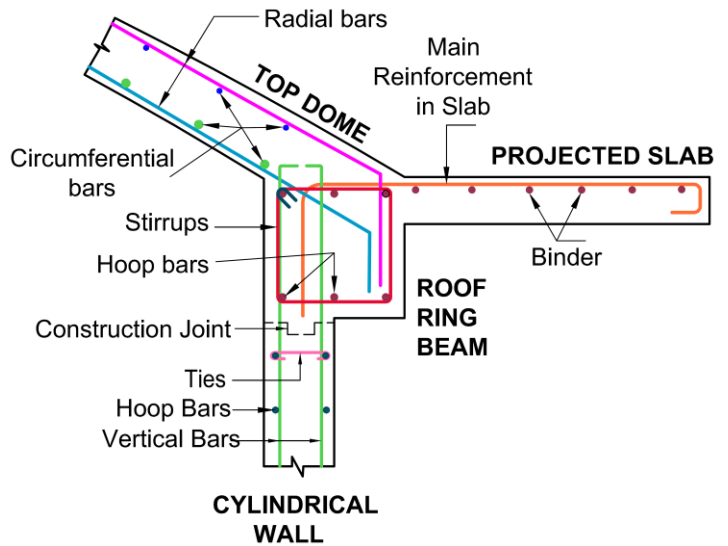

**10.15 TOP DOME**

**10.15.1 REINFORCEMENT PLAN**

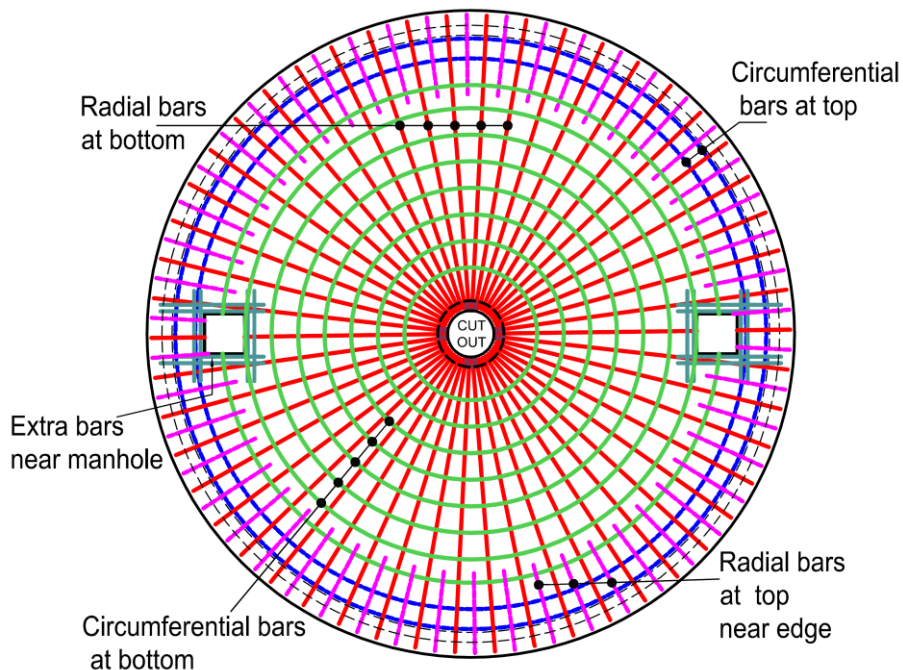

**10.15.2 SECTION**

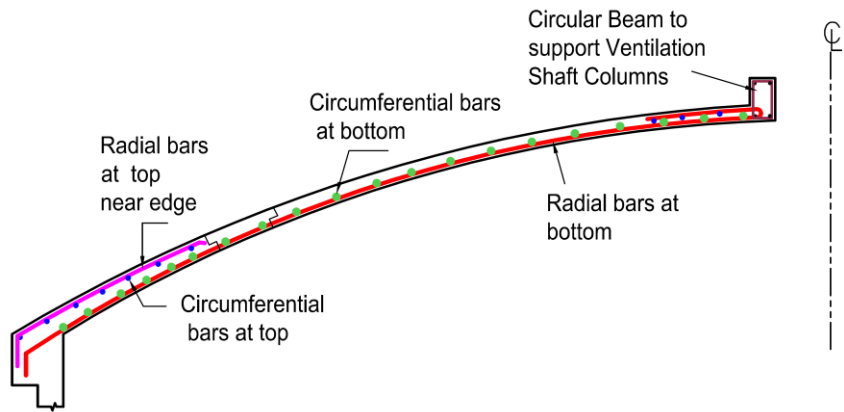

**10.16 VENTILATION SHAFT**

**10.16.1 PLAN SHOWING SUPPORTING COLUMN**

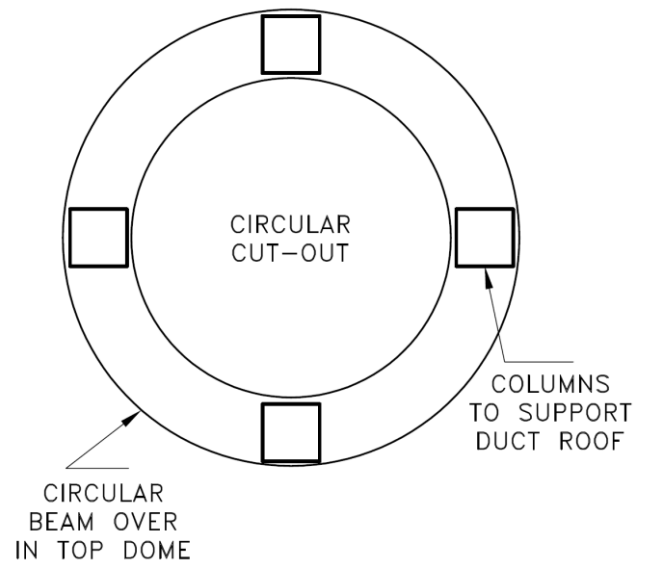

**10.16.2 SECTION**

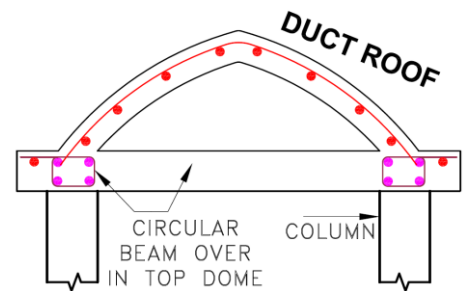

# GUIDELINES FOR R.C. WATER TOWERS UPTO 1000 kL CAPACITY

## Part- 2 CONSTRUCTION CONTROL PROVISIONS

As stipulated in IS: 456, IS: 3370 & IS: 11682\*

### 1.0 GENERAL

जल ही जीवन है।

- It is most important to ensure water supply even under post – earthquake situation.
- Water Towers are important structure.
- IS:1893-Part 2 stipulates that 1.5 times the normal seismic forces should be considered in designs.

Hence, Construction Control procedure should be laid down for quality assurance.

### 1.1 REASONS OF WEAKNESS OF STRUCTURE

- Foundation on weak soil
- Improper structural arrangement
- Deficient structural design
- Lack of checking of designs
- Lack of detailed structural drawing
- Poor connection of non- structural elements with main structure
- Poor construction material
- Untrained construction labour
- Lack of Supervision / Inspection

### 2.0 FOUNDATION

#### 2.1 SELECTION OF SITE **IS: 3370 Part I clause 4, IS: 1904-1986 clause 5.3**

Extra precaution is needed at the following sites:

- Saturated fine sand below the foundation
- Expansive clay or loose silt below the foundation
- Filled up sites
- Sloping ground
- Water-logging at the site
- Chemically injurious soil or ground water

#### 2.2 OBJECT OF SUBSURFACE INVESTIGATION

- To determine shear strength and compressibility of soil layers **(IS: 1892– 1979)**
- To determine soil type: Hard, Medium or Soft soil **(IS: 1893 Part 1)**

#### 2.3 SUBSURFACE INVESTIGATION **IS:1892– 1979**

- ✓ Minimum Depth of Borehole = Depth of foundation + 1.5 x diameter of foundation
- ✓ In weak soil, exploration up to a depth at which the loads can be carried
- ✓ Highest Annual flood level, Depth of Underground water table before and after monsoon
- ✓ Chemical analysis of the soil and ground water

---

\*Prepared by: **B K MISHRA, Senior Advisor, Bihar State Disaster Management Authority** for  
**Training on quality assurance in construction of RCC water tanks and towers**

## 2.4 NECESSARY SOIL TESTS OF DIFFERENT LAYERS

- Standard Penetration Test \* (IS 2131-1981)
- Visual classification of soil (IS 1498 - 1970)
- Grain size analysis (IS 2720 Part IV)
- Unit weight and Specific gravity (IS 2720 Part III)
- Natural moisture content (IS 2720 Part II)
- Plastic and Liquid limits (IS 2720 Part V)
- Unconfined compression (IS 2720 Part X)
- Tri-axial compression, C,  $\phi$  (IS 2720 Part XI)
- Direct Shear test (sandy soil) (IS 2720 Part XIII)
- Coefficient of consolidation for Cohesive soil (IS 2720 Part XV)
- Chemical analysis including pH determination (IS 2720 Part XXVI)
- Chlorides and sulphates (IS 2720 Part XXVII)

\* Supervision is necessary during various operation, e.g. Boring, Logging and sampling.

## 2.5 RECOMMENDATIONS IN SOIL TEST REPORT

- Depth of Foundation to achieve bearing pressure
- Type of foundation to be adopted
- Discussions for
  - Possible Liquefaction
  - Expansion and contraction of soil due to seasonal changes?
  - Foundation soil is not eroded by flowing water?
- Calculation for Safe bearing capacity of Open foundation
  - On shear failure criteria IS: 6403 – 1981
  - On settlement criteria IS: 8009 (Part I) – 1976

☞ If necessary, Shear capacity and settlement can be verified separately, by the Plate Load Test, as per IS: 1888 – 1982

## 2.6 SAFETY AND STABILITY OF FOUNDATION

IS: 3370 Part I clause 4.2

- Proportioning the foundation for safe bearing pressure
- Permissible settlement IS: 1904-1986 Table 1
- No tension at base (under seismic condition)
- Safety against sliding and overturning IS: 1904-1986 clause 17
- RCC tie beams for isolated foundations
- Protecting coat against injurious soils: asphalt, chlorinated rubber, epoxy or polyurethane

## 3.0 DEFECTS IN CONCRETE

### 3.1 SEGREGATION

- Coarse aggregate separate out from the paste
- Bottom: surplus of aggregate, large voids, reduced strength, less durability
- Top, lack of aggregate, cracking

### 3.2 BLEEDING OF WATER

- Aggregates cannot hold water and Cement-water rises to the surface.
- Bleeding continues until the cement paste has stiffened enough to end the sedimentation process
- Causes
  - Lack of fines, Excess of water, Non-cohesive mix
  - Inappropriate placing and Insufficient compaction

### 3.3 PLASTIC SHRINKAGE CRACKING

- Rate of water evaporation > rate of bleeding water to the top
- Drying while concrete is plastic
  - surface cracking
  - Loss of bond between concrete and rebar

### 3.4 CONTROL OF PLASTIC SHRINKAGE

- Reduce evaporation of water
  - Cool concrete, use ice
  - Use curing compound
  - Erect wind barriers
  - Cover with polyethylene
- Increase the humidity
  - Moisten forms
  - Spray water

### 3.5 HONEYCOMBING

- Too much coarse aggregate and Lack of paste
- Causes: Poor compaction, Rebar congestion, Joint leakages

### 3.6 CORROSION IS: 3370 Part I clause 5.1, 9.8

- Low cement content
- Less Compaction
- Less cover to steel

### 3.7 INCOMPLETE COMPACTION (DEFECTS)

- 5% of air voids loss of strength by 30%
- 10% of air voids loss of strength by 60%

## 4.0 EXECUTION OF WORK

Work to be carried out under an experienced supervisor (IS: 11682)

### 4.1 MATERIALS

#### 4.1.1 CEMENT

- Use 43 grade OPC (IS: 8112), Slag cement (IS: 455) or PPC (IS: 1489)
- Cement must be fresh, Protect from moisture
- Cement mixture should be used within an hour after adding the water
- Manufactures: Ultra tech, JP cement, Lafarge, Birla Gold, (ISI marked)

#### 4.1.2 WATER

- Clean (like drinking water)

#### 4.1.3 STONE CHIPS

- Provides volume stability
- Use 20 mm to 4.75 mm, Well graded (IS 383)
- Clean and Fresh, Protect from dust

#### 4.1.4 RIVER SAND

- 4.75 mm to 75 micron, FM > 2
- Well graded zone II (IS 383) zone II
- Clean and Fresh, Protect from dust

#### 4.1.5 ADMIXTURE: SUPER PLASTICISER **IS 9103-1999**

- ✓ Improves workability of concrete
- ✓ Reduces required water up to 12% or more
- Approve with past experience and mix design
- Maximum weight, 2 % by weight of cement
- Establish slump with and without the use of admixtures

#### 4.1.6 STEEL REINFORCING BARS

- High Yield strength deformed steel bars conforming to **IS 1786**.
- Standard manufacturer such as Tata, SAIL
- Do not use bars manufactured from (re-rolled steel)

#### 4.1.7 FORMWORK

- Gives concrete its shape
- Formwork must be: accurate, strong and no leak from the joints
- Formwork placed, can be removed
- Simple to build, easy to handle and re-useable
- Materials: steel, ply board, timber
- Bolts to secure and align the form-work: Don't pass completely through walls / slabs, unless, or, take precautions for water-tightness, **(IS: 3370 P1 Cl. 9.7)**
- Face of formwork in contact with concrete **(IS: 456 2000 Cl. 11.2)**
  - Clean and treat with form release agent
  - Release agents should not coat the reinforcement

### **4.2 CONSTRUCTION CONTROL** **(IS: 1893 - Part-2, Clause 8.2.3)**

- a) Vertical Alignment – The centre point of shaft shall not vary from its vertical axis by more than 0.2 percent of shaft height.
- b) Over any height of 1.6 m, wall of shaft shall not be out of plumb by more than 10 mm.
- c) Shaft diameter – the measured centerline diameter of shaft at any section shall not vary from the specified diameter by more than 20 mm plus 0.1 percent of the specified theoretical diameter.
- d) Shaft thickness – the measured wall thickness shall not vary from the specified wall thickness by more than – 5 mm or + 10 mm.

### **4.3 ASSEMBLY OF REINFORCEMENT**

- Bar bending schedule to be prepared
- Bars to be placed as shown in the drawings
- Steel bars not to be re-bent
- Proper position by using cover blocks, spacers, chairs etc.
- Keep beam and column bars straight at joints
- Beam bars should pass within column bars
- Welded Joints or Mechanical Connections: Test the joints for full strength of bars



#### 4.4 CONCRETE COVER TO REINFORCEMENT

Cover provided to protect corrosion of reinforcing bar

- Proper cover blocks casted a month earlier
- Chair is used for top layer bars in slab

NOMINAL COVER

(IS 456 2000 Clause 26.4)

✓ Depth of concrete cover to steel bars, including links

- Nominal Cover  $\geq$  diameter of main bar
- Nominal cover for Moderate Exposure 30 mm

**Nominal cover < Actual concrete cover < Nominal cover + 10 mm**

- Minimum cover for footings = 50 mm
- Minimum cover to long bar in column = 40 mm

**IS: 3370 (Part II) clause 7.2**

- Liquid face and inner face of roof, 25 mm
- In corrosive soil, minimum cover = 50+12 mm

#### 4.5 CONCRETE GRADE, W/C RATIO & CEMENT QUANTITY

(IS 456 2000 Table 3, Table 5)

- Exposure condition: Mild, Moderate, Severe, Very severe, Extreme
- Adopt exposure: Moderate (Exposed to rain or under water)
- Minimum concrete grade M25
- 20 mm nominal maximum size aggregate
- Minimum quantity of cement in RCC  $\geq$  300 kg / cum
- Maximum water / cement ratio  $\leq$  0.5

**IS: 3370 Part I clause 3.1**

- Minimum quantity of cement in RCC  $\geq$  330 kg / cum
- Maximum quantity of cement in RCC  $\leq$  530 kg / cum

#### 4.6 CONCRETE PROPORTIONING

(IS 456 2000 Clause 10)

- Material should be stocked at least a day before use
- The grading of aggregates to be checked frequently
- Proportion, type and grading of aggregates to obtain densest concrete
- Mix design as per **IS 10262-1982**
- Allowance moisture and bulking to be made
- Weigh-batching of all ingredients of the concrete
- In case of volume batching, mass volume relationship to be checked frequently

#### 4.7 CONCRETE MIXING

- Always machine mixing
- Mixers to be fitted with water measuring devices
- Maintain water-cement ratio
- Pour 25% of the total quantity of water into the drum
- Discharge dry coarse and fine aggregates into the drum
- Deposit full quantity of cement into the drum
- Pour balance quantity of water
- 25 to 30 revolutions are needed for mixing with drum rotating @ 15-20 revolutions per minute, Mixing time, at least 2 min
- Continue mixing till uniform colour and consistency
- Slump to be checked at frequent intervals

#### 4.8 WORKABILITY

- Easy to mix, place, compact and finish
- Easy to flow (slump)

##### MEASUREMENT OF SLUMP IS: 1199-1959

- Cone not bent or dented, clean surface inside
- Keep cone on clean, stable and levelled flat base of adequate size
- representative sample, middle fraction from the mixer
- Fill the cone, in three layers,
- Tamping with 16 mm diameter bar, each layer 25 times
- scrape off the surface, Lift cone vertically
- Measure the subsidence, Record the result
- Details: date, concrete batch, members

##### (IS 456 2000 clause 7.1)

- 50-100 mm slump heavily reinforced sections in slabs, beams, walls, columns

#### 4.9 CONCRETE CASTING, COMPACTION

- Maximum free fall 1.5 m.
- Keep proper space at the joints for concreting
- Vibrate and compact before initial setting
- Compaction may be by immersion vibrator
- Compact thoroughly around the reinforcement and embedded fixtures
- Compact by 16 mm bar at congested locations, comers and edges
- Design the formwork for location, if external vibrator is used
- Uniform and full compaction

#### 4.10 CONSTRUCTION JOINT IS: 3370 Part I clause 8, 9 and IS 456 2000 Clause 13.4

- Position of joints between successive lifts should be indicated on the drawings
- The height of any lift  $\leq 2$  m unless precautions are taken to ensure compaction
- Prepare Joint Surface of the first-placed concrete
  - Surface film be removed immediately after initial setting
  - Expose the aggregate and leave a sound irregular surface.
  - This may be achieved by air or water jet and wire brush.
  - Prepare clean SSD condition surface.
  - If the concrete has hardened, the desired surface may be achieved by hacking the whole of the surface, without damaging the aggregate.
- Curing of the joint surface may be suspended a few hours before second concreting
- The roughened joint surface should be thoroughly cleaned and freed from loose matter and then treated with a thin layer of cement grout, worked well into the surface
- Special care should be taken to avoid segregation of the concrete along the joint plane and to obtain thorough compaction.
- Alternatively, for horizontal joints the layer of grout or mortar may be omitted, provided that the workability of first batches of concrete placed in contact with the joint is slightly increased

#### 4.11 CURING OF CONCRETE

(IS 456 2000 Clause 13.5)

##### CURING

- Prevents the loss of moisture
- Maintains temperature gradients within
- Ample water, do not let it dry
- Dry concrete = dead, all reactions stop, Cannot revitalize if dries
- Curing is important in low w/c ratio, high rate of strength development
- Begin the curing of exposed surface as soon as the surface has hardened i.e. 1 to 2 hours after placement and finishing
- Exposed horizontal surfaces of concrete shall be kept wet by ponding
- Exposed vertical surfaces of concrete shall be kept wet by covering with sacking, canvas, hessian etc.
- Period of curing at least 10 days for OPC and 14 days for PPC
- Temperature > 45°, fast setting, durability suffers
- Best temperature is room temperature

#### 4.12 REMOVAL OF FORMWORK

(IS 456 2000 Clause 11.3.1)

- If temperature does not fall below 15°C and adequate curing is done

| Period for Striking Formwork               |             |         |
|--|-------------|---------|
| Type of Formwork                           | For OPC     | For PPC |
| Vertical formwork to columns, walls, beams | 16 – 24 hrs | 24 hrs  |
| Props to beams and arches:                 |             |         |
| 1) Spanning up to 6 m                      | 14 days     | 21 days |
| 2) Spanning over 6 m                       | 21days      | 24 days |

- In spherical dome formwork to be removed from centre towards sides

## 5.0 TESTS OF CONSTRUCTION MATERIALS

### 5.1 SIEVE ANALYSIS OF SAND AND STONE CHIPS

- Sieve analysis of Sand, stone chips and their mix (IS: 2386 P1 Cl. 2)
- Limits of deleterious materials as per IS: 383 1970 Table 1
- Sieve analysis of, stone chips, IS: 383 1970 Table 2
- Sieve analysis of Sand, IS: 383 1970 Table 4
- Mix of sand and stone chips (All in aggregate) IS: 383 1970 Table 4

#### PROCEDURE

- ✓ Dry
- ✓ Weigh 1000 gm of fine aggregate & 2000 gm of coarse aggregate
- ✓ 2 minutes in sieve shaker then weigh & take % passing.

| Sieve      | Sand zone-II | Stone chips 20mm | Stone chips 10mm | All in aggregate |
|------------|--------------|------------------|------------------|------------------|
| 40         | -            | 100              | -                | 100              |
| 20         | -            | 85-100           | -                | 95-100           |
| 12.5       | -            | -                | 100              | -                |
| 10         | -            | 0-20             | 85-100           | 25-35            |
| 4.75       | 90-100       | 0-5              | 0-20             | 0-10             |
| 2.36       | 75-100       | -                | 0-5              | -                |
| 1.18       | 55-90        | -                | -                | -                |
| 600 micron | 35-59        | -                | -                | -                |
| 300 micron | 8-30         | -                | -                | -                |
| 150 micron | 0-10         | -                | -                | -                |
| 75 micron  | -            | -                | -                | -                |

## 5.2 TESTS FOR REINFORCING BARS

Mass per meter **IS: 1786-1985 Table 1**

| <b>STRENGTH &amp; ELOGATION IS: 1786-1985 Table 3</b> |           |           |           |
|---|-----------|-----------|-----------|
| Test  | Fe 415    | Fe 500    | Fe 550    |
| Minimum 0.2 percent proof stress / yield stress       | 415.0 mpa | 500.0 mpa | 550.0 mpa |
| Minimum elongation in %                               | 14.5 %    | 12.0 %    | 8.0 %     |

Minimum yield stress is stress at 0.2 % elongation

Minimum elongation is measured at fracture

## 5.3 TESTS FOR CEMENT

**IS: 4031 Part V 1988 Clause 2**

Initial setting time > 30 min, Final setting time < 600 min

| <b>Compressive strength of 70.6 mm size cube, IS: 4031 Part 6</b> |                   |        |        |         |
|---|-------------------|--------|--------|---------|
| Cement  | IS code           | 3 days | 7 days | 28 days |
| 33 Grade OPC  | <b>IS 269</b>     | 16 mpa | 22 mpa | 33 mpa  |
| Portland Slag Cement  | <b>IS 455</b>     | 16 mpa | 22 mpa | 33 mpa  |
| PPC   | <b>IS 1489 P1</b> | 10 mpa | 18 mpa | 33 mpa  |
| 43 Grade OPC  | <b>IS 8112</b>    | 23 mpa | 33 mpa | 43 mpa  |
| 53 Grade OPC  | <b>IS 12269</b>   | 27 mpa | 37 mpa | 53 mpa  |
| Approximate Strength  |                   | 50 %,  | 70 %   | 100 %   |

## 5.4 CONCRETE CUBE TESTS

Sampling as per **IS: 1199-1959 clause 3**

Cubes made, cured and tested as per **IS: 516-1959**

- 15 cm Moulds: clean and properly bolted, A steel tamping bar
- Oil the moulds with proper shutter oil
- Representative sample of fresh concrete, Compact the concrete in layers
- Cover the cubes with wet hessian covered with polythene
- Label the cubes and keep records

### 5.4.1 SAMPLE OF CONCRETE CUBE

**IS: 456-2000 Clause 15**

- One sample from each Shift
- One sample = 3 test specimens
- Test Result = average of the strength of 3 specimens
- Specimen test result variation <  $\pm 15\%$  of the average

### 5.4.2 TEST RESULT OF SAMPLE CONCRETE CUBE

**IS: 456-2000 Clause 15.4**

- Test Result = 28 days strength
- For quicker idea of quality, 7 days tests

### 5.4.3 ACCEPTANCE CRITERIA

**IS 456 2000 Clause 16.1**

| Concrete in m3 | Number of Samples |
|----------------|-------------------|
| 1 - 5          | 1                 |
| 6 - 15         | 2                 |
| 16 - 30        | 3                 |
| 31 - 50        | 4                 |
| 51 - 100       | 5                 |
| 100 - 150      | 6 .....           |

- Mean of 4 consecutive test results >  $f_{ck} + 0.825 \times \text{standard deviation}$ ,  
and >  $f_{ck} + 4 \text{ mpa}$
- Any individual test result >  $f_{ck} - 4 \text{ mpa}$

## 5.5 TESTS FOR WATER TIGHTNESS AT FULL SUPPLY LEVEL IS: 3370 P1 Cl. 10

External faces should not show signs of leakage and remain apparently dry over the period of 7 days after filling.

## 6.0 IMPORTANT BIS CODES

### Safety of Structure

**IS: 456 – 2000** Plain and Reinforced Concrete – Code of Practice

**IS: 3370 – 1965** Code of practice for concrete structures for the storage of liquids:  
(Part I) general requirements  
(Part II) Reinforced Concrete Structures

**IS: 11682 -1985** Criteria for design of RCC staging for overhead water tanks

**IS: 1893 (P2) - 2002** Criteria for Earthquake Resistant Design of Liquid retaining tanks

**IS: 13920 - 1993** Ductile detailing of RCC structures against EQ forces: Code

### Protection of Foundation

**IS: 1498-1970** Classification and identification of soils for engineering purposes

**IS: 1892- 1979** Subsurface investigation for foundations: Code of Practice

**IS: 1904- 1986** Foundations in Soils: Code for General Requirements

**IS: 2131- 1981** Method of Standard Penetration Test for soils (First Revision)

**IS: 2950 Part 1-1981** Design and Construction of Raft foundations: Code of Practice

**IS: 6403- 1981** Determination of bearing capacity of Shallow foundations: Code

**IS: 8009 Part 1** Calculation of settlement of shallow foundation: Code

### Tests for Construction Materials

**IS: 383- 1970** Specification for coarse and fine aggregates for concrete

**IS: 516- 1959** Methods of tests for strength of concrete

**IS: 1199- 1959** Methods of sampling and analysis of concrete

## 7.0 SUPERVISION, INSPECTION AND DOCUMENTATION OF CONSTRUCTION

### 7.1 SUPERVISION (IS 456 2000 Clause 13.6)

- Constant and strict supervision of all construction items
  - ✓ Formwork for sizes of structural elements, Level of formwork
  - ✓ Reinforcement and its placing
  - ✓ Proportioning, mixing of and Compaction the concrete
  - ✓ Curing and Stripping of the formwork

### 7.2 TEST REPORTS AND CERTIFICATES

- Test reports and certificates for materials
- Concrete mix design details
- Concrete Pour Details
- Concrete mix test reports
- Site order book,
  - ✓ Record of geometry and reinforcement checking
  - ✓ Clearance for concrete placement
  - ✓ non-conformance reports

### 7.3 INSPECTION (IS 456 2000 Clause 17.1, 17.2)

- Set up inspection procedure, quality assurance scheme
- Ensure compliance of design in construction
- Verify quality of individual parts
- Tests and Records of construction materials
- Clear instructions on inspection and permissible deviations
- Identify workmanship, durability & appearance

## 7.4 SUPERVISION CHECK LIST

### 7.4.1 Before actual start of construction: use CHECK LIST : 1

| CHECK LIST : 1   |                                    | PRE- CONSTRUCTION                      |      |
|--|------------------------------------|--|------|
| Name of Project with Location ?                                  |                                    |  |      |
| Name of equipment required ?                                     |                                    |  |      |
| Cement, Aggregate, Sand, Admixtures, water & Steel Reinforcement | Available <input type="checkbox"/> | Not Available <input type="checkbox"/> |      |
| Space for storage of materials                                   | Available <input type="checkbox"/> | Not Available <input type="checkbox"/> |      |
| Temporary sheds, drinking water and toilets                      | Available <input type="checkbox"/> | Not Available <input type="checkbox"/> |      |
| Trained Mason and Labor  | Available <input type="checkbox"/> | Not Available <input type="checkbox"/> |      |
| Site Order Book  | Available <input type="checkbox"/> | Not Available <input type="checkbox"/> |      |
| Note : Fill in the blanks or tick the check box.                 |                                    |  |      |
| Engineer   | Name                               | Signature                              | Date |
| JE   |                                    |  |      |
| AE   |                                    |  |      |

### 7.4.2 With the supply of every new lot of construction materials : use CHECK LIST : 2

| CHECK LIST : 2   |   | CONSTRUCTION MATERIALS                |   |
|--|---|---------------------------------------|---|
| Name of Project with Location ?                                      |   |                                       |   |
| Type of cement   | PPC <input type="checkbox"/>                  | Slag cement <input type="checkbox"/>  | OPC 33 Gr. <input type="checkbox"/> OPC 43 Gr. <input type="checkbox"/> |
| Manufacturing week of cement ?                                       |   |                                       |   |
| Cement cube test   | DONE <input type="checkbox"/>                 | NOT DONE <input type="checkbox"/>     |   |
| Concrete cube test after Mix Design                                  | DONE <input type="checkbox"/>                 | NOT DONE <input type="checkbox"/>     |   |
| Proportion of materials by Weight, as per Mix design ?               | Cement: sand: chips: water: super-plasticizer |                                       |   |
| Proportion of materials by Volume, as per Mix design ?               | Cement: sand: chips: water: super-plasticizer |                                       |   |
| Sieve analysis of stone chips conforms to IS:383.                    | YES <input type="checkbox"/>                  | NO <input type="checkbox"/>           |   |
| Sieve analysis of sand conforms to IS:383.                           | YES <input type="checkbox"/>                  | NO <input type="checkbox"/>           |   |
| Sieve analysis of All in Aggregates conforms to IS:383.              | YES <input type="checkbox"/>                  | NO <input type="checkbox"/>           |   |
| Aggregates are free from dust and foreign matter                     | YES <input type="checkbox"/>                  | NO <input type="checkbox"/>           |   |
| Aggregates are protected from environmental dust                     | YES <input type="checkbox"/>                  | NO <input type="checkbox"/>           |   |
| Test for steel reinforcement as per IS:1786: Value of Yield stress ? |   |                                       |   |
| Test for steel reinforcement as per IS:1786: Value for Elongation ?  |   |                                       |   |
| Water is clean and portable  | YES <input type="checkbox"/>                  | NO <input type="checkbox"/>           |   |
| Value of Slump with Super-plasticizer ?                              |   |                                       |   |
| Value of Slump without Super-plasticizer ?                           |   |                                       |   |
| Photograph: Cement Store   | ATTACHED <input type="checkbox"/>             | NOT ATTACHED <input type="checkbox"/> |   |
| Photograph: Aggregates   | ATTACHED <input type="checkbox"/>             | NOT ATTACHED <input type="checkbox"/> |   |
| Note : Fill in the blanks or tick the check box.                     |   |                                       |   |
| Engineer   | Name  | Signature                             | Date  |
| JE   |   |                                       |   |
| AE   |   |                                       |   |

- 7.4.3 For construction of Foundation, Staging, Bottom dome & Conical Ring Beam, Middle Ring Beam, Cylindrical Wall and Top Dome : use **CHECK LIST : 3, CHECK LIST : 4 and CHECK LIST : 5.**

| <b>CHECK LIST : 3</b>                                     |                                       | <b>CENTERING-SHUTTERING AND REBARS PLACING</b> |                                      |
|---|---------------------------------------|--|--------------------------------------|
| Name of Project with Location ?                           |                                       |  |                                      |
| Materials used for formwork                               | WOODEN PLANK <input type="checkbox"/> | PLY BOARD <input type="checkbox"/>             | STEEL PLATE <input type="checkbox"/> |
| Materials used for props                                  | STEEL PIPE <input type="checkbox"/>   | SAL BALLAH <input type="checkbox"/>            | BAMBOO <input type="checkbox"/>      |
| Shuttering is sufficiently strong to bear the loads.      | YES <input type="checkbox"/>          | NO <input type="checkbox"/>                    |                                      |
| Props are strong, properly placed, fixed and tied.        |                                       |  | <input type="checkbox"/>             |
| Inner face of formwork is smooth.                         | YES <input type="checkbox"/>          | NO <input type="checkbox"/>                    |                                      |
| Inner face of formwork is cleaned.                        | YES <input type="checkbox"/>          | NO <input type="checkbox"/>                    |                                      |
| Inner face of formwork is treated with form release agent | YES <input type="checkbox"/>          | NO <input type="checkbox"/>                    |                                      |
| Vertical & horizontal alignment is as per drawing.        |                                       | YES <input type="checkbox"/>                   | NO <input type="checkbox"/>          |
| The width and depth/height of formwork is as per drawing. |                                       | YES <input type="checkbox"/>                   | NO <input type="checkbox"/>          |
| Vertical sides should be absolutely in line and plumb.    |                                       | YES <input type="checkbox"/>                   | NO <input type="checkbox"/>          |
| The formwork is water-tight.                              |                                       | YES <input type="checkbox"/>                   | NO <input type="checkbox"/>          |
| Thin sheets are provided along joints of wooden formwork. |                                       | YES <input type="checkbox"/>                   | NO <input type="checkbox"/>          |
| Foam is provided along the joint of steel formwork.       |                                       | YES <input type="checkbox"/>                   | NO <input type="checkbox"/>          |
| Width of section is adequate for inserting vibrator.      |                                       | YES <input type="checkbox"/>                   | NO <input type="checkbox"/>          |
| Proper location, size & orientation of cut-outs.          |                                       | YES <input type="checkbox"/>                   | NO <input type="checkbox"/>          |
| Proper location and size of inserts & bolts.              |                                       | YES <input type="checkbox"/>                   | NO <input type="checkbox"/>          |
| Bars are rust free.                                       |                                       | YES <input type="checkbox"/>                   | NO <input type="checkbox"/>          |
| Bars are straight.  |                                       | YES <input type="checkbox"/>                   | NO <input type="checkbox"/>          |
| Bar diameter, length and spacing is as per drawing.       |                                       | YES <input type="checkbox"/>                   | NO <input type="checkbox"/>          |
| Bars are bent as and placed as per drawing.               |                                       | YES <input type="checkbox"/>                   | NO <input type="checkbox"/>          |
| The lap length is accurate as per drawing.                |                                       | YES <input type="checkbox"/>                   | NO <input type="checkbox"/>          |
| Laps are staggered.                                       |                                       | YES <input type="checkbox"/>                   | NO <input type="checkbox"/>          |
| Adequate and accurate cover blocks & chairs.              |                                       | YES <input type="checkbox"/>                   | NO <input type="checkbox"/>          |
| Minimum 25 mm clear distance between two bars.            |                                       | YES <input type="checkbox"/>                   | NO <input type="checkbox"/>          |
| The rods are tied properly with binding wire.             |                                       | YES <input type="checkbox"/>                   | NO <input type="checkbox"/>          |
| Walk-way planks to be used while casting the slab.        |                                       | YES <input type="checkbox"/>                   | NO <input type="checkbox"/>          |
| Over all cleaning done before concreting.                 |                                       | YES <input type="checkbox"/>                   | NO <input type="checkbox"/>          |
| Photograph: multiple view of works                        |                                       | ATTACHED <input type="checkbox"/>              | NO <input type="checkbox"/>          |
| Photograph: Subject of technical interest.                |                                       | ATTACHED <input type="checkbox"/>              | NO <input type="checkbox"/>          |
| Photograph: Any unusual difficulty                        |                                       | ATTACHED <input type="checkbox"/>              | NO <input type="checkbox"/>          |
| Photograph: Safety violations, Accident scenes, Defects   |                                       | ATTACHED <input type="checkbox"/>              | NO <input type="checkbox"/>          |
| ALLOWED FOR CONCRETING                                    |                                       | YES <input type="checkbox"/>                   | NO <input type="checkbox"/>          |
| <i>Note : Fill in the blanks or tick the check box.</i>   |                                       |  |                                      |
| Engineer  | Name                                  | Signature                                      | Date                                 |
| JE  |                                       |  |                                      |
| AE  |                                       |  |                                      |

| <b>CHECK LIST : 4</b>   |                              | <b>CORCRETE MAKING, CASTING, CUBE MAKING</b> |                             |
|---|------------------------------|--|-----------------------------|
| Name of Project with Location ?                                     |                              |  |                             |
| Spare Vibrator and needles was kept ready before concreting.        | YES <input type="checkbox"/> | NO <input type="checkbox"/>                  |                             |
| Additional precaution was taken for shuttering during concreting.   | YES <input type="checkbox"/> | NO <input type="checkbox"/>                  |                             |
| Slump was tested at regular intervals to ensure proper workability. | YES <input type="checkbox"/> | NO <input type="checkbox"/>                  |                             |
| Concrete was not poured from more than 1.5 m height                 | YES <input type="checkbox"/> | NO <input type="checkbox"/>                  |                             |
| Concrete was compacted properly.                                    | YES <input type="checkbox"/> | NO <input type="checkbox"/>                  |                             |
| Concrete top is at proper level.                                    | YES <input type="checkbox"/> | NO <input type="checkbox"/>                  |                             |
| Construction joints are properly made at correct location.          | YES <input type="checkbox"/> | NO <input type="checkbox"/>                  |                             |
| Concrete surface was finished properly.                             | YES <input type="checkbox"/> | NO <input type="checkbox"/>                  |                             |
| Concrete was used within initial setting (after adding the water).  | YES <input type="checkbox"/> | NO <input type="checkbox"/>                  |                             |
| Concrete cubes was made for testing.                                | YES <input type="checkbox"/> | NO <input type="checkbox"/>                  |                             |
| Concrete sample was collected from random mixes.                    | YES <input type="checkbox"/> | NO <input type="checkbox"/>                  |                             |
| Adequate number of cube samples taken for test at 7 & 28 days.      | YES <input type="checkbox"/> | NO <input type="checkbox"/>                  |                             |
| Photograph: Multiple view of works                                  |                              |  |                             |
|   |                              | YES <input type="checkbox"/>                 | NO <input type="checkbox"/> |
| Photograph: Defective work  |                              |  |                             |
|   |                              | YES <input type="checkbox"/>                 | NO <input type="checkbox"/> |
| <i>Note : Fill in the blanks or tick the check box.</i>             |                              |  |                             |
| Engineer  | Name                         | Signature                                    | Date                        |
| JE  |                              |  |                             |
| AE  |                              |  |                             |

| <b>CHECK LIST : 5</b>                                      |                              | <b>CURING AND STRIPPING OF FORMWORK</b> |                             |
|--|------------------------------|---|-----------------------------|
| Name of Project with Location ?                            |                              |   |                             |
| For how many days curing was continuously done ?           |                              |   |                             |
| Curing compound was used for member not easily accessible. | YES <input type="checkbox"/> | NO <input type="checkbox"/>             |                             |
| After how many days Formwork was removed ?                 |                              |   |                             |
| 7 days Cube Test Results ?                                 |                              |   |                             |
| 28 days Cube Test Results ?                                |                              |   |                             |
| Photograph: multiple view of works                         |                              |   |                             |
|  |                              | YES <input type="checkbox"/>            | NO <input type="checkbox"/> |
| Photograph: Defective work                                 |                              |   |                             |
|  |                              | YES <input type="checkbox"/>            | NO <input type="checkbox"/> |
| <i>Note : Fill in the blanks or tick the check box.</i>    |                              |   |                             |
| Engineer   | Name                         | Signature                               | Date                        |
| JE   |                              |   |                             |
| AE   |                              |   |                             |

7.4.4 **CHECK LIST : 6** shall be used to inform weekly progress of works.

| <b>CHECK LIST : 6</b>                                   |                                   | <b>WEEKLY CONSTRUCTION REPORT</b> |      |
|---|-----------------------------------|-----------------------------------|------|
| Name of Project with Location ?                         |                                   |                                   |      |
| Weather (temperature, cloud, rain etc.) ?               |                                   |                                   |      |
| Indicate any major decision taken ?                     |                                   |                                   |      |
| Members constructed during the week ?                   |                                   |                                   |      |
| Equipment working in the activity ?                     |                                   |                                   |      |
| Name of Contractor's technical person ?                 |                                   |                                   |      |
| Corrective actions, if any to be taken ?                |                                   |                                   |      |
| Problems or delays and resolution ?                     |                                   |                                   |      |
| Communications with contractor staff ?                  |                                   |                                   |      |
| Progress photos, (where applicable).                    | ATTACHED <input type="checkbox"/> | NO <input type="checkbox"/>       |      |
| <i>Note : Fill in the blanks or tick the check box.</i> |                                   |                                   |      |
| Engineer  | Name                              | Signature                         | Date |
| JE  |                                   |                                   |      |
| AE  |                                   |                                   |      |



7.4.5 **CHECK LIST : 7** shall be used for any non compliance of works or specification.

| <b>CHECK LIST : 7</b>      |                          | <b>NONCONFORMITY REPORT</b> |                          |        |                          |
|----------------------------|--------------------------|-----------------------------|--------------------------|--------|--------------------------|
| Project ?                  |                          |                             |                          |        |                          |
| Contractor ?               |                          |                             |                          |        |                          |
| Structural Element ?       |                          |                             |                          |        |                          |
| Item of Work ?             |                          |                             |                          |        |                          |
| Summary of Nonconformity ? |                          |                             |                          |        |                          |
| Suggestions ?              |                          |                             |                          |        |                          |
| Use as it is               | <input type="checkbox"/> | Repair                      | <input type="checkbox"/> | Reject | <input type="checkbox"/> |
| Engineer                   | Name                     | Signature                   | Date                     |        |                          |
| JE                         |                          |                             |                          |        |                          |
| AE                         |                          |                             |                          |        |                          |

## 7.5 INSPECTION CHECK LIST

**CHECK LIST : 8** shall be used by senior engineers like EE, SE or CE during their inspection of works.

| <b>CHECK LIST : 8</b>                                   |                                 | <b>INSPECTION CHECK LIST</b>  |      |
|---|---------------------------------|-------------------------------|------|
| Name of Project with Location ?                         |                                 |                               |      |
| Date of inspection ?                                    |                                 |                               |      |
| Structural member inspected in the inspection ?         |                                 |                               |      |
| Concrete Cube Test results                              | PASSED <input type="checkbox"/> | FAIL <input type="checkbox"/> |      |
| Tests of construction materials conform to IS Codes.    | YES <input type="checkbox"/>    | NO <input type="checkbox"/>   |      |
| Tests of construction materials conform to IS Codes.    | YES <input type="checkbox"/>    | NO <input type="checkbox"/>   |      |
| Construction has been done as per drawing.              | YES <input type="checkbox"/>    | NO <input type="checkbox"/>   |      |
| Workmanship & appearance are satisfactory.              | YES <input type="checkbox"/>    | NO <input type="checkbox"/>   |      |
| Segregation or honeycombing on the concrete surface.    | SEEN <input type="checkbox"/>   | NO <input type="checkbox"/>   |      |
| Photograph: taken properly and kept properly            | YES <input type="checkbox"/>    | NO <input type="checkbox"/>   |      |
| <i>Note : Fill in the blanks or tick the check box.</i> |                                 |                               |      |
| Engineer  | Name                            | Signature                     | Date |
| EE <input type="checkbox"/> SE <input type="checkbox"/> |                                 |                               |      |

## 7.6 DOCKETING

Table below shows the name of the offices where documents and reports will be kept safe for future references.

| Documents and Reports                         | Office of       |
|---|-----------------|
| Soil Investigation Report                     | ENC, CE, SE, EE |
| Design Calculations and Drawing Details       | ENC, CE, SE, EE |
| Detailed Drawings                             | EE, AE, JE      |
| All Check lists, photographs and Test Reports | CE, SE, EE      |
| Geometric and Rebar measurements              | EE, AE, JE      |

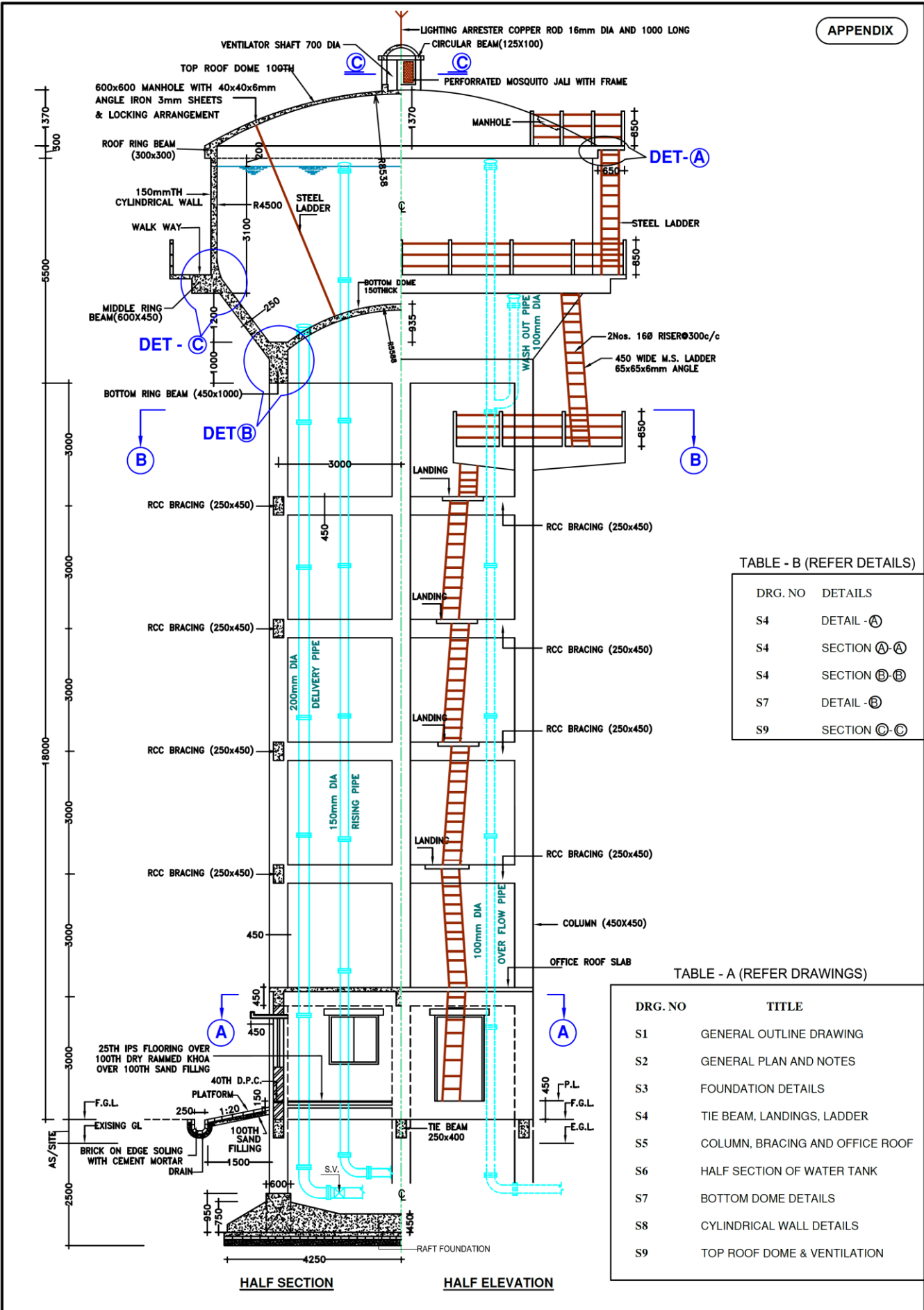

TABLE - B (REFER DETAILS)

| DRG. NO | DETAILS     |
|---------|-------------|
| S4      | DETAIL - A  |
| S4      | SECTION A-A |
| S4      | SECTION B-B |
| S7      | DETAIL - B  |
| S9      | SECTION C-C |

TABLE - A (REFER DRAWINGS)

| DRG. NO | TITLE                           |
|---------|---------------------------------|
| S1      | GENERAL OUTLINE DRAWING         |
| S2      | GENERAL PLAN AND NOTES          |
| S3      | FOUNDATION DETAILS              |
| S4      | TIE BEAM, LANDINGS, LADDER      |
| S5      | COLUMN, BRACING AND OFFICE ROOF |
| S6      | HALF SECTION OF WATER TANK      |
| S7      | BOTTOM DOME DETAILS             |
| S8      | CYLINDRICAL WALL DETAILS        |
| S9      | TOP ROOF DOME & VENTILATION     |

GENERAL NOTES:-

1. ALL DIMENSIONS ARE IN mm .
2. FOR CONCRETE MIX REFER TABLE-I
3. "Tor" INDICATES TOR STEEL YIELD STRENGTH 415 N/mm<sup>2</sup>.  
Ø INDICATES PLAIN ROUND MILD STEEL BARS.
4. ALL CONCRETE SHALL BE MACHINE MIXED AND MACHINE VIBRATED.
5. STRUCTURAL DESIGN OF R.C.C. ELEMENT CONFIRM TO IS:456-2000, IS:3370(Pt.II)1965,IS:1893-2002,IS:4326-1976.
6. THE WATER TOWER HAS BEEN DESIGNED FOR SEISMIC FORCE ADOPTING EARTHQUAKE ZONE IV AS PER IS:1893-2002 ( PART II)
7. COLD TWISTED HIGH YIELD STRENGTH DEFORMED BARS CONFIRMING TO IS:1786-1985 SHALL BE USED.
8. C.I. D/F PIPE FITTING AND SLUICE VALVE SHALL CONFIRM TO IS:7181-1975, IS:1538-1975, & IS:780-1984 RESPECTIVELY.
9. ALL DIMENSIONS ARE TO BE READ NOT TO BE MEASURED.
10. THE BEARING CAPACITY OF SOIL ADOPTED AS 12.0MT/M<sup>2</sup>.
11. REFER TABLE - II FOR LAP LENGTH & TABLE - III FOR COVERS.
12. LAP LENGTH FOR COLUMNS SHALL BE 40 TIMES DIA OF THE BAR.
13. LAP LENGTH FOR OTHER ELEMENTS (NOT SHOWN IN TABLE-II) OF WATER TOWER SHALL BE 47 TIMES DIA OF THE BAR.
14. REFER TABLE - IV FOR SCHEDULE OF DOORS & WINDOWS.
15. NOT MORE THAN 1/3 OF THE BAR SPliced AT ANY SECTION IN CYLINDRICAL WALL , TOP DOME, BOTTOM DOME , CONICAL WALL, TOP RING BEAM & BOTTOM RING BEAM OF THE TANK.
16. NOT MORE THAN 50% OF THE BAR IN COLUMNS & BEAMS SHALL BE SPliced AT ONE SECTION.

TABLE - I (CONCRETE MIX)

| ELEMENTS   | CONCRETE GRADE |
|--|----------------|
| ROOF DOME<br>ROOF RING BEAM<br>CYLINDRICAL WALL<br>MIDDLE RING BEAM<br>CONICAL WALL<br>BOTTOM DOME<br>BOTTOM RING BEAM | M25            |
| COLUMNS<br>BRACINGS<br>OFFICE ROOM ROOF<br>TIE BEAM<br>FOUNDATION  | M20            |

TABLE - II (COVER)

| ELEMENTS  | COVER      |            |
|---|------------|------------|
|   | INNER FACE | INNER FACE |
| TOP DOME  | 30mm       | 20mm       |
| ROOF RING BEAM<br>CYLINDRICAL WALL<br>MIDDLE RING BEAM<br>CONICAL WALL<br>BOTTOM DOME | 40mm       | 25mm       |
| BOTTOM RING BEAM<br>BRACINGS<br>TIE BEAM  | 25mm       |            |
| COLUMNS   | 40mm       |            |
| OFFICE ROOM ROOF<br>SLAB  | 20mm       |            |
| FOUNDATION  | 50mm       |            |

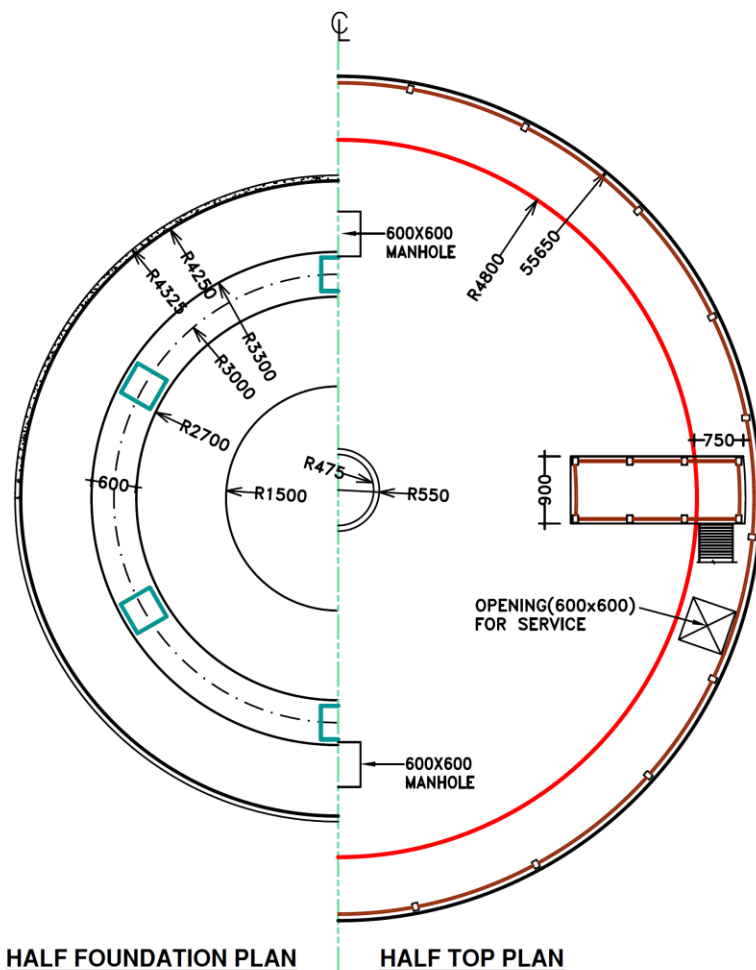

TABLE - III (LAP LENGTH)

| ELEMENTS  | LAP LENGTH |
|---|------------|
| CIRCUMFERENTIAL BAR OF CYLINDRICAL WALL & CONICAL WALL          | 1.4 x Ld   |
| CIRCUMFERENTIAL (HOOP) BAR OF ROOF RING BEAM & MIDDLE RING BEAM | 2 x Ld     |
| <b>Ld = 47 x DIAMETER OF BAR</b>                                |            |

TABLE - IV (OFFICE ROOM OPENINGS)

| SCHEDULE OF DOORS & WINDOWS |       |        |
|-----------------------------|-------|--------|
| TYPE                        | WIDTH | HEIGHT |
| D                           | 1200  | 2100   |
| D1                          | 750   | 2100   |
| W                           | 1500  | 1200   |
| V                           | 450   | 450    |

225 KL CAPACITY INTZE TYPE RCC WATER TOWER, STAZING 18M IN SEISMIC ZONE IV.

DRAWING No.

S-2

TITLE

GENERAL PLAN AND NOTES

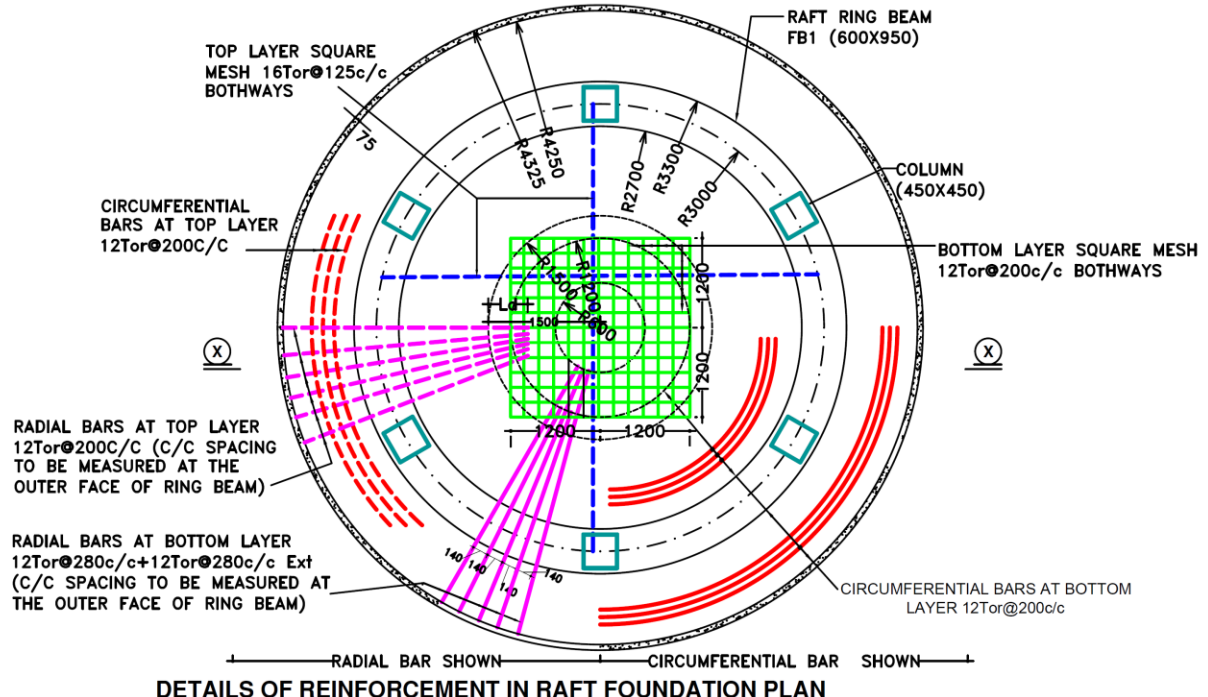
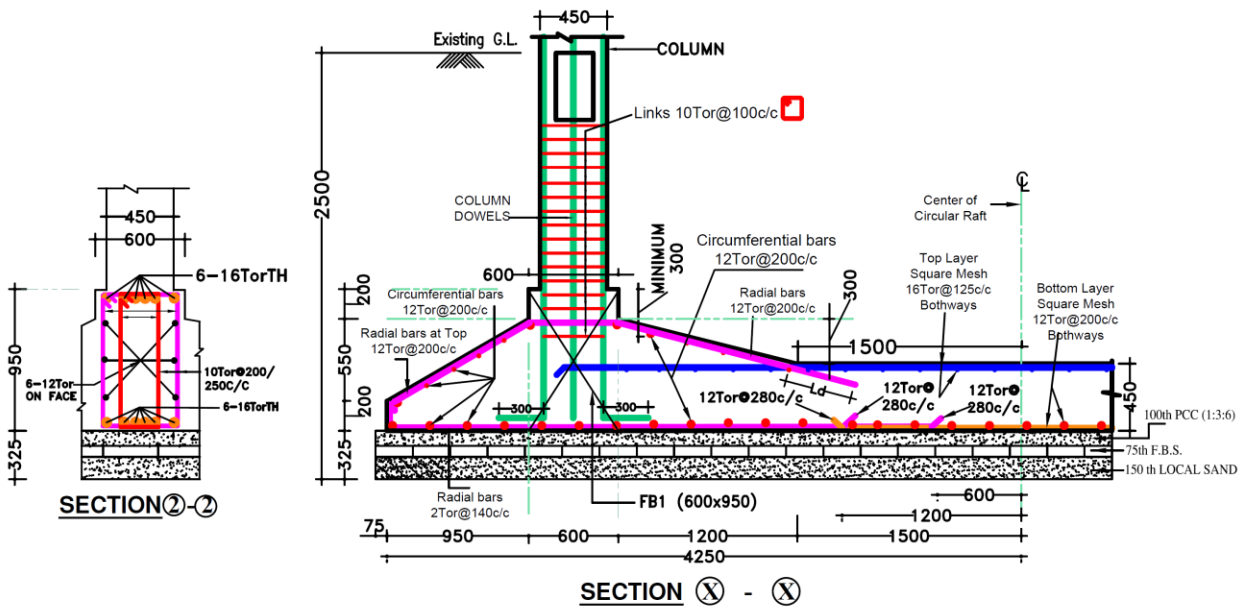
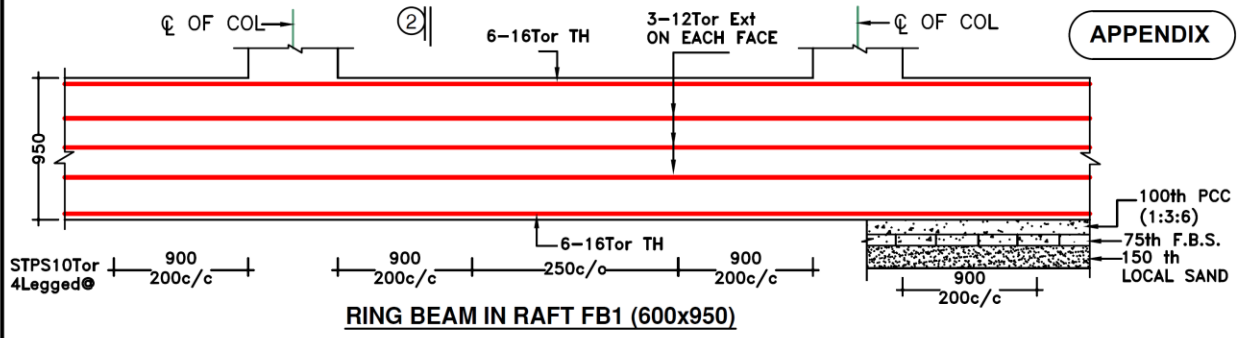

NOTES :-  
 RAFT REINFORCEMENT SHOWN IN PLAN  
 TOP REINFORCEMENT SHOWN THUS .....  
 BOTTOM REINFORCEMENT SHOWN THUS \_\_\_\_\_

|  |                        |                                 |
|--|------------------------|---------------------------------|
| <p>225 KL CAPACITY INTZE TYPE RCC WATER TOWER, STAZING 18M IN SEISMIC ZONE IV.</p> | <p>DRAWING No. S-3</p> | <p>TITLE FOUNDATION DETAILS</p> |
|--|------------------------|---------------------------------|

APPENDIX

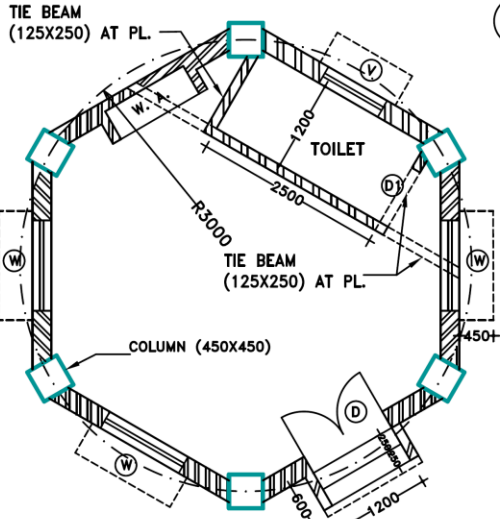

PLAN OFFICE ROOM ON SECTION-A-A

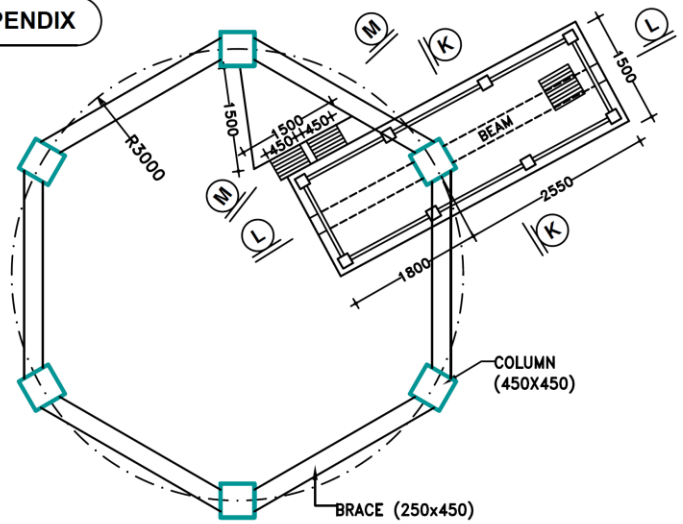

SECTION-B-B

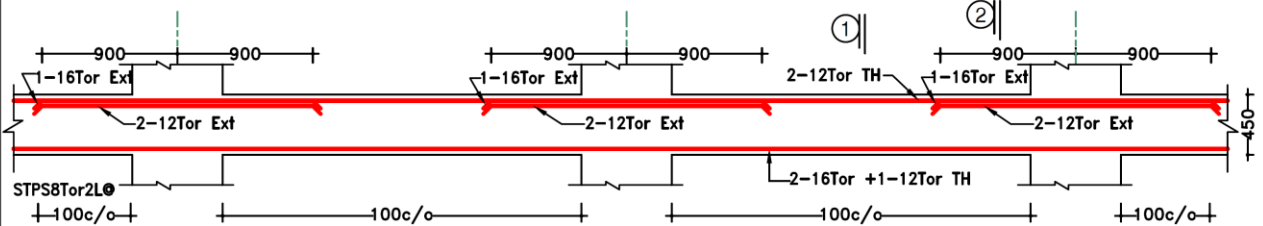

DETAILS OF TIE BEAM (250x450) (TOP AT EXISTING GROUND Lv. OR AT FINISHED GL.)

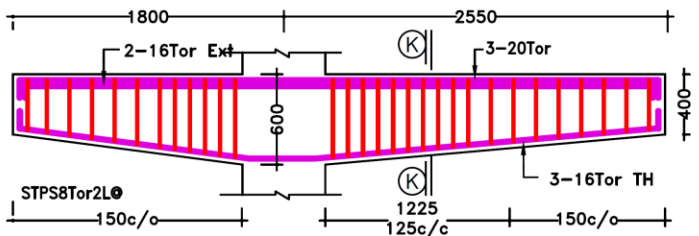
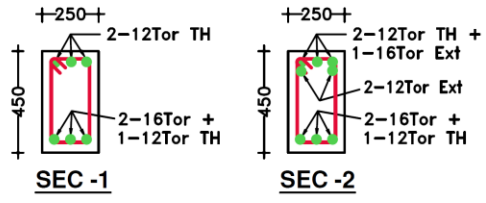

DETS OF LANDING BEAM AT SEC - L - L

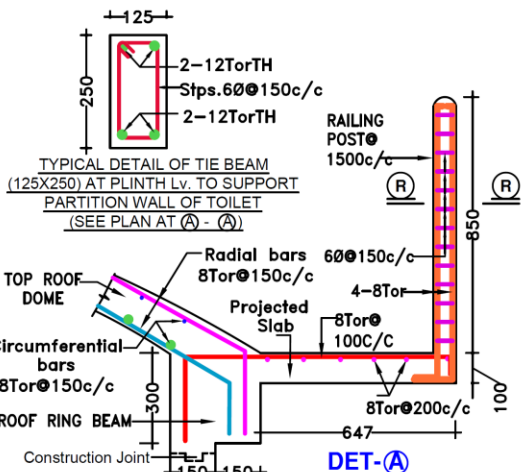

TYPICAL DETAIL OF TIE BEAM (125X250) AT PLINTH Lv. TO SUPPORT PARTITION WALL OF TOILET (SEE PLAN AT (A) - (A))

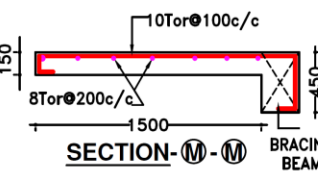

SECTION-M-M

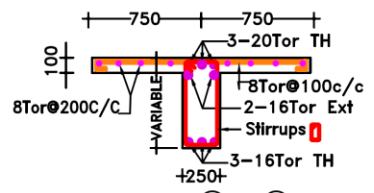

SEC - K - K LANDING SLAB DETAIL

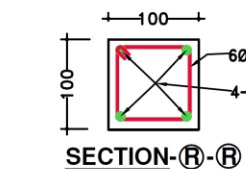

SECTION-R-R

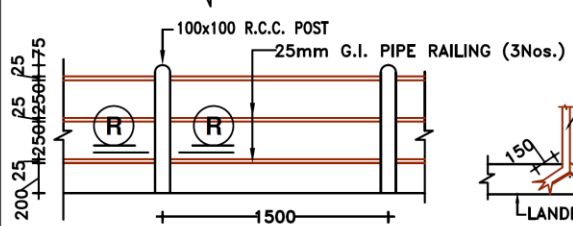

DETS OF RAILING

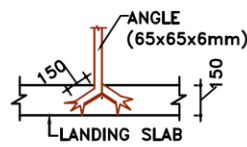

FIXING OF LADDER

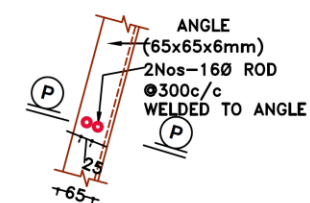

DETAILS OF LADDER

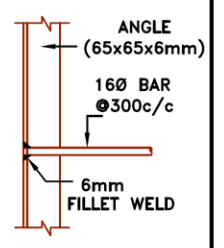

SECTION-P-P

225 KL CAPACITY INTZE TYPE RCC WATER TOWER, STAZING 18M IN SEISMIC ZONE IV.

DRAWING No.

S-4

TITLE

TIE BEAM, LANDINGS, LADDER

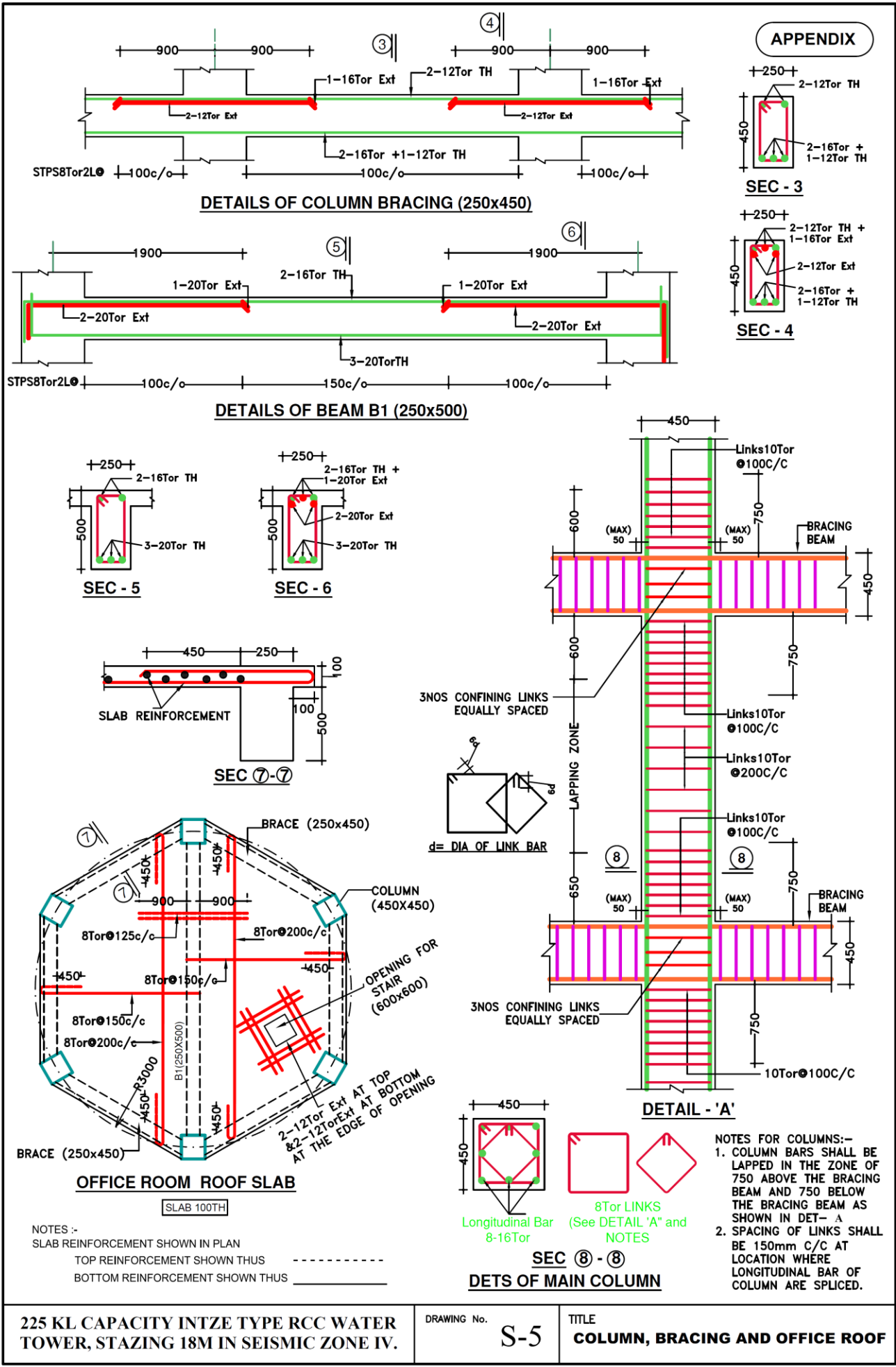

**APPENDIX**

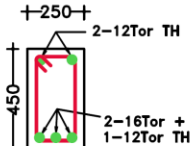

**SEC - 3**

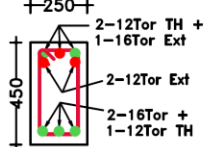

**SEC - 4**

**DETAILS OF COLUMN BRACING (250x450)**

**DETAILS OF BEAM B1 (250x500)**

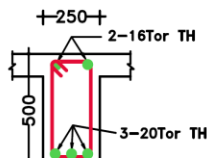

**SEC - 5**

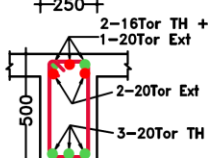

**SEC - 6**

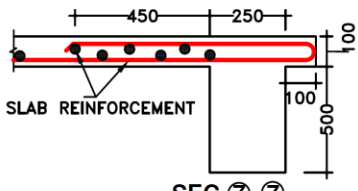

**SEC 7-7**

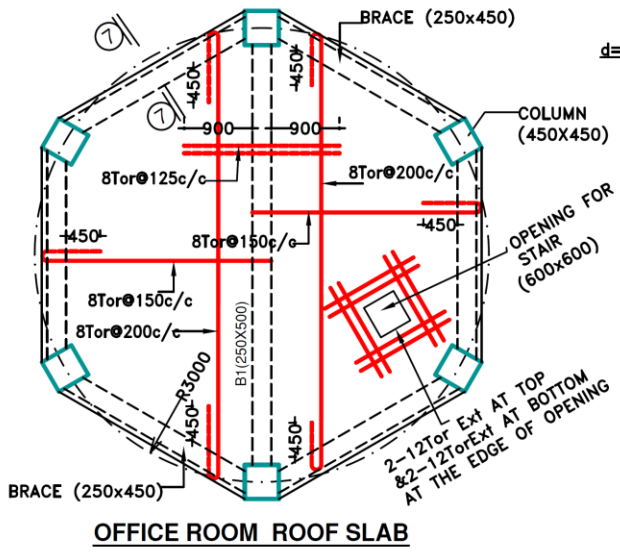

**OFFICE ROOM ROOF SLAB**

SLAB 100TH

NOTES :-  
 SLAB REINFORCEMENT SHOWN IN PLAN  
 TOP REINFORCEMENT SHOWN THUS -----  
 BOTTOM REINFORCEMENT SHOWN THUS \_\_\_\_\_

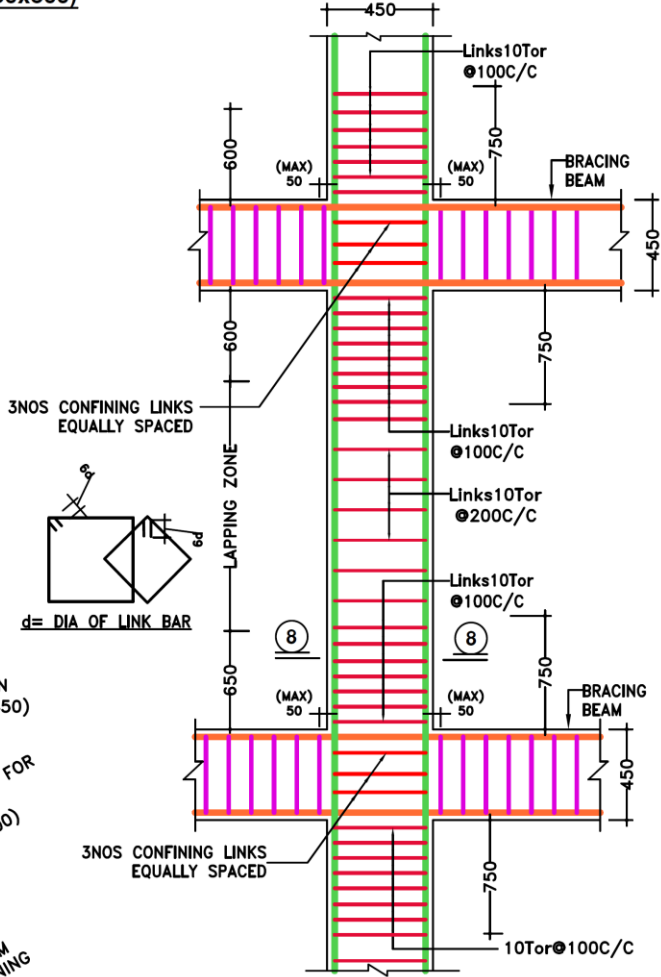

**DETAIL - 'A'**

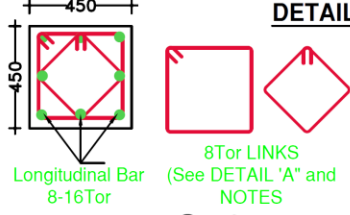

**SEC 8-8**

**DETS OF MAIN COLUMN**

NOTES FOR COLUMNS:-  
 1. COLUMN BARS SHALL BE LAPPED IN THE ZONE OF 750 ABOVE THE BRACING BEAM AND 750 BELOW THE BRACING BEAM AS SHOWN IN DET- A  
 2. SPACING OF LINKS SHALL BE 150mm C/C AT LOCATION WHERE LONGITUDINAL BAR OF COLUMN ARE SPLICED.

|   |                               |   |
|---|-------------------------------|---|
| <p><b>225 KL CAPACITY INTZE TYPE RCC WATER TOWER, STAZING 18M IN SEISMIC ZONE IV.</b></p> | <p>DRAWING No. <b>S-5</b></p> | <p>TITLE <b>COLUMN, BRACING AND OFFICE ROOF</b></p> |
|---|-------------------------------|---|

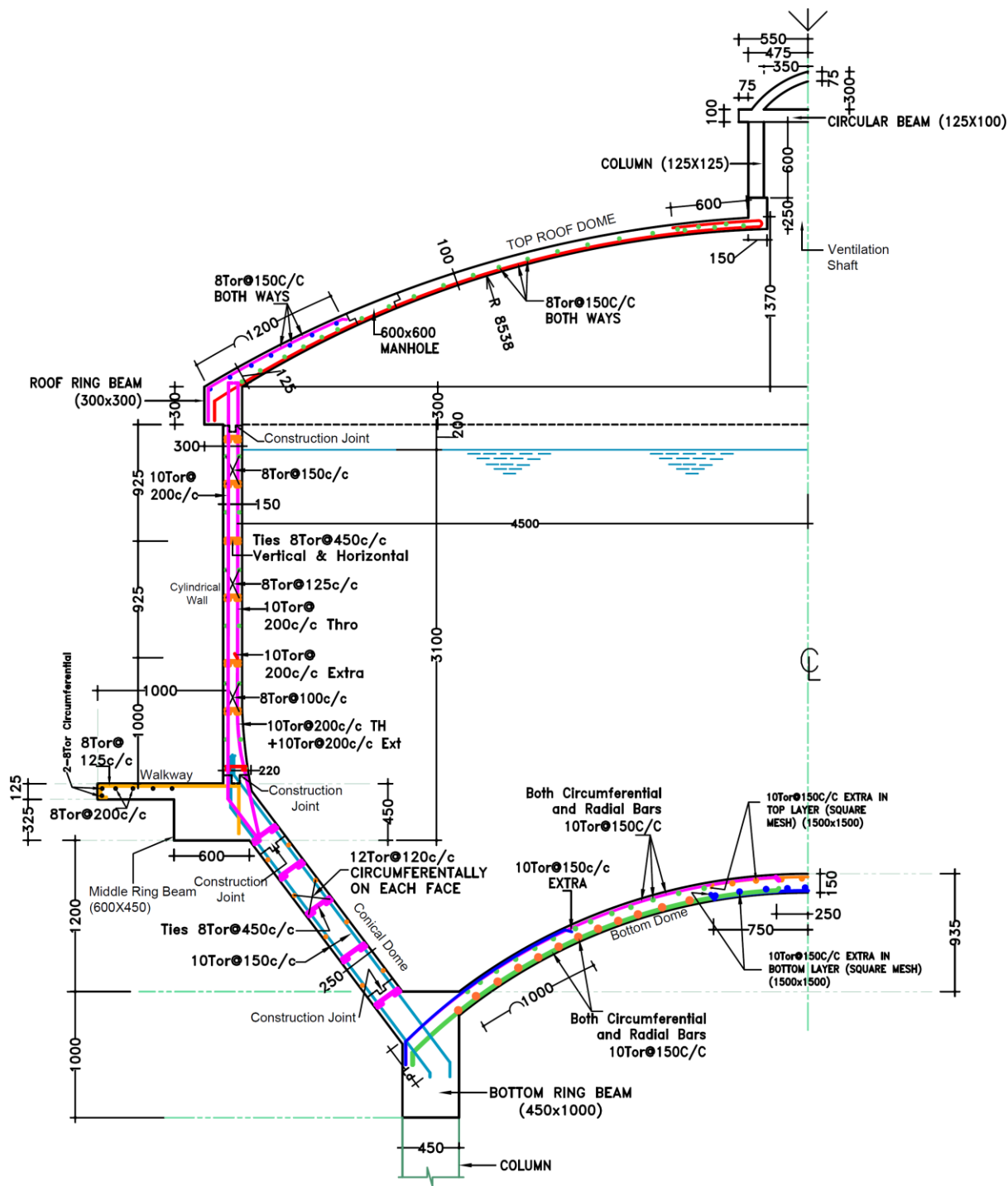

HALF SECTION OF WATER TANK

225 KL CAPACITY INTZE TYPE RCC WATER TOWER, STAZING 18M IN SEISMIC ZONE IV.

DRAWING No. S-6

TITLE HALF SECTION OF WATER TANK

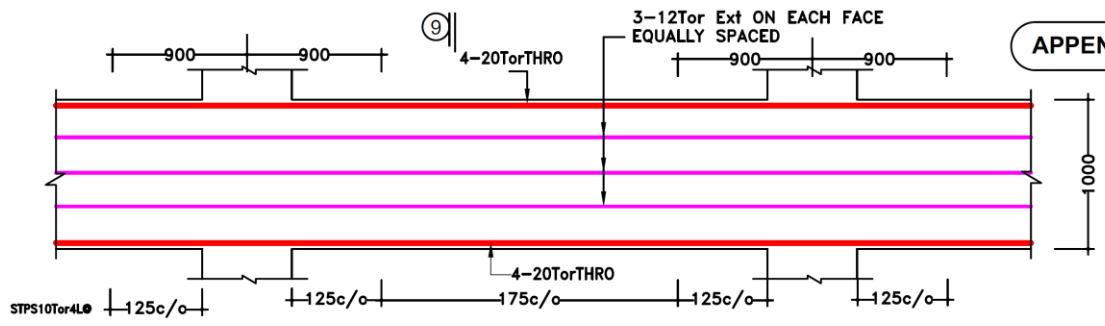

**DETAILS OF BOTTOM RING BEAM IN TANK (450x1000)**

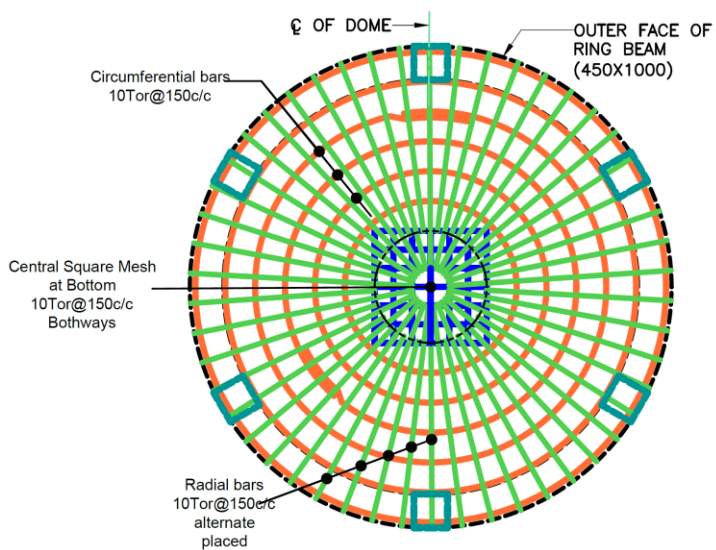

**PLAN SHOWING ARRANGEMENT OF BOTTOM STEEL IN BOTTOM DOME**

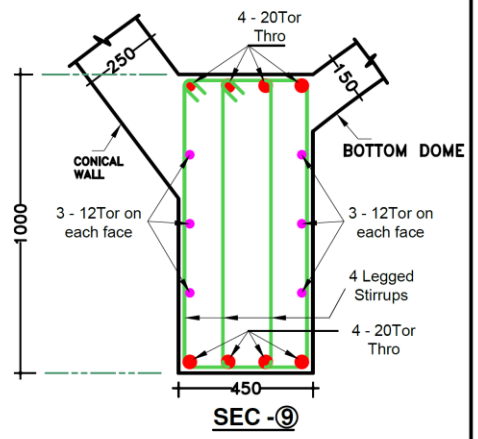

**SEC - 9**

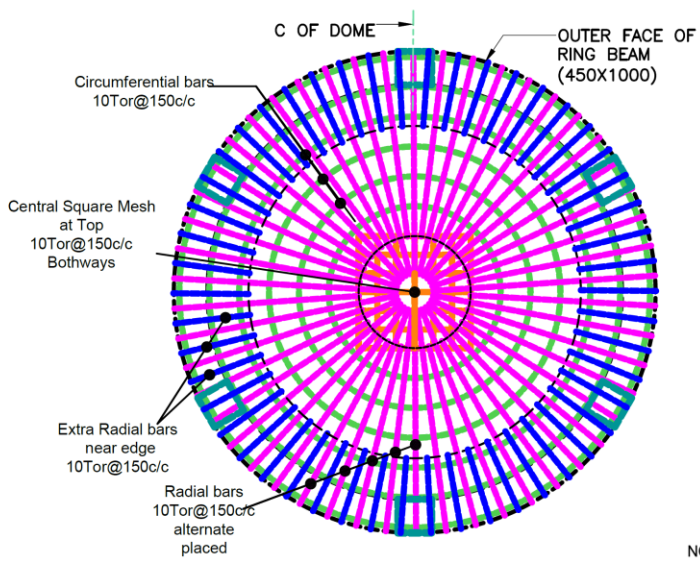

**PLAN SHOWING ARRANGEMENT OF TOP STEEL IN BOTTOM DOME**

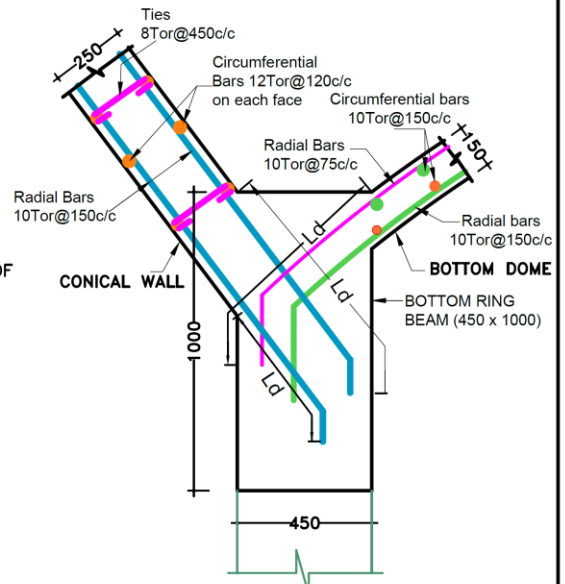

**DETAIL B JUNCTION OF CONICAL WALL - BOTTOM RING BEAM - BOTTOM DOME**

NOTES :-  
 BOTTOM DOME REINFORCEMENT SHOWN IN PLAN  
 TOP REINFORCEMENT SHOWN THUS   
 BOTTOM REINFORCEMENT SHOWN THUS

|  |                        |   |
|--|------------------------|---|
| <p>225 KL CAPACITY INTZE TYPE RCC WATER TOWER, STAZING 18M IN SEISMIC ZONE IV.</p> | <p>DRAWING No. S-7</p> | <p>TITLE <b>BOTTOM DOME DETAILS</b></p> |
|--|------------------------|---|



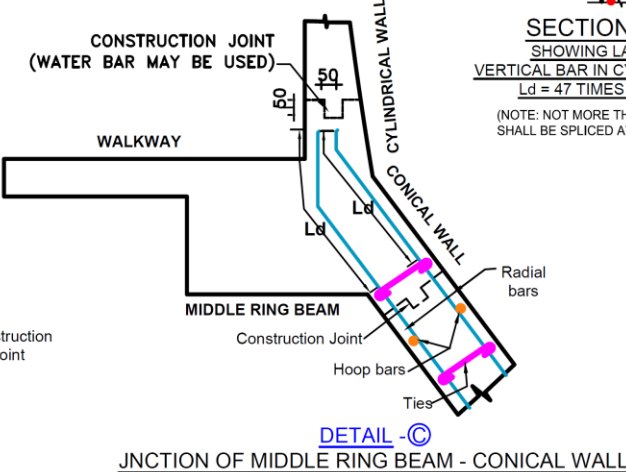
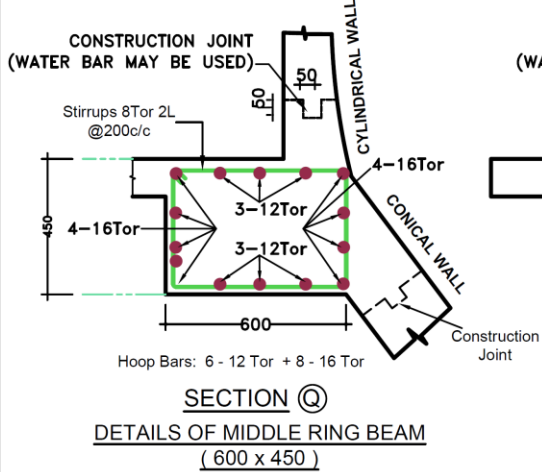
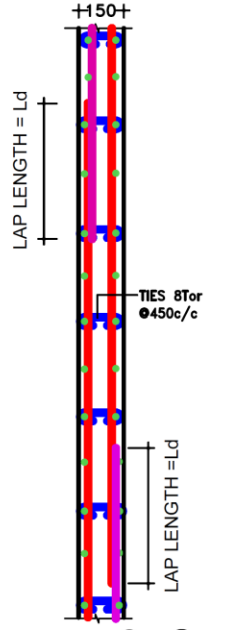
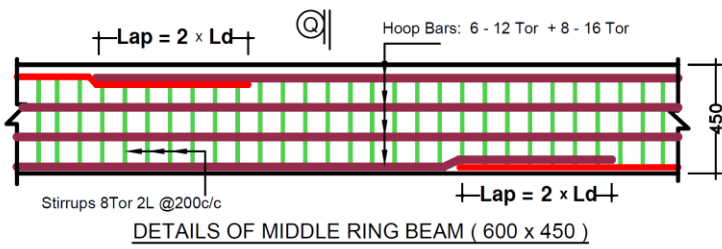
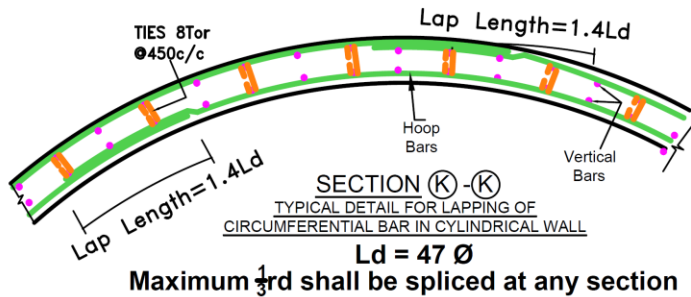
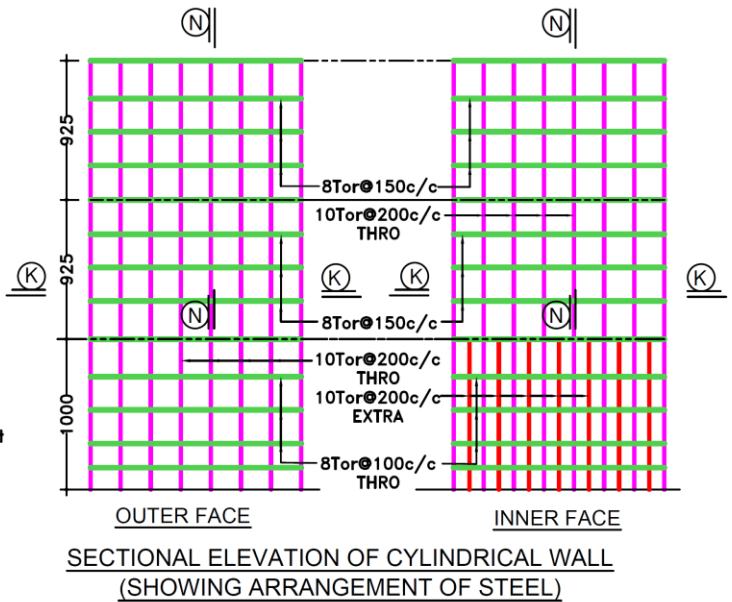
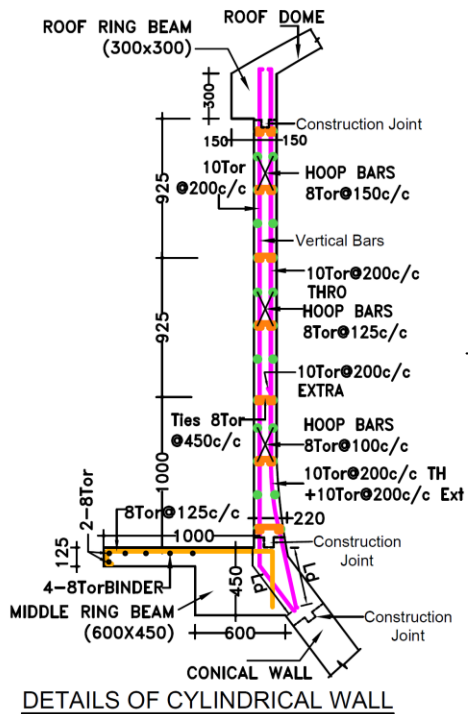

|  |                        |                                       |
|--|------------------------|---------------------------------------|
| <p>225 KL CAPACITY INTZE TYPE RCC WATER TOWER, STAZING 18M IN SEISMIC ZONE IV.</p> | <p>DRAWING No. S-8</p> | <p>TITLE CYLINDRICAL WALL DETAILS</p> |
|--|------------------------|---------------------------------------|

**APPENDIX**

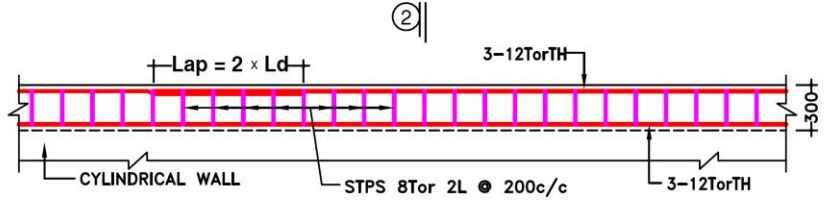

**DETAILS OF ROOF RING BEAM(300x300)**

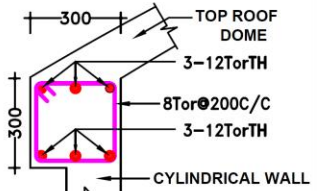

**SEC -2**

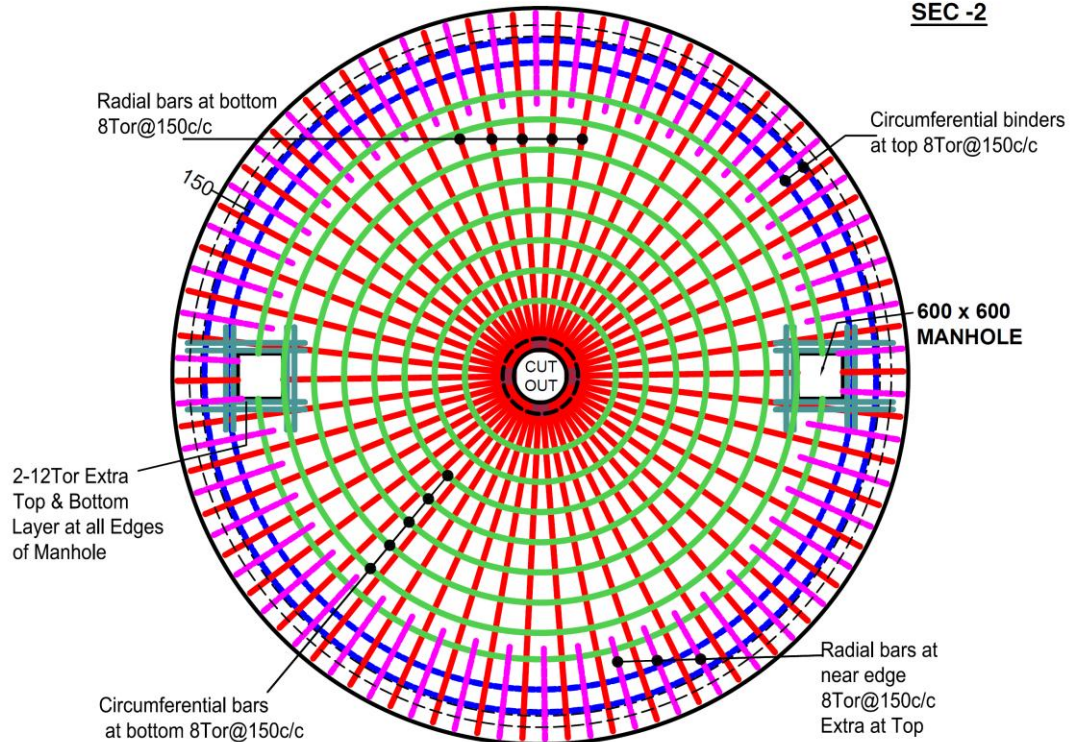

**PLAN**

**SHOWING ARRANGEMENT OF REINFORCEMENT TOP ROOF DOME**

NOTES :-  
 TOP ROOF DOME REINFORCEMENT SHOWN IN PLAN  
 TOP REINFORCEMENT SHOWN THUS -----  
 BOTTOM REINFORCEMENT SHOWN THUS \_\_\_\_\_

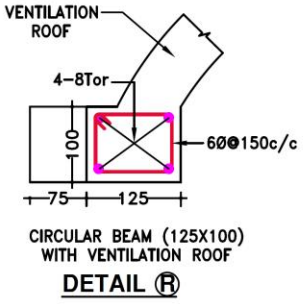

**DETAIL (R)**

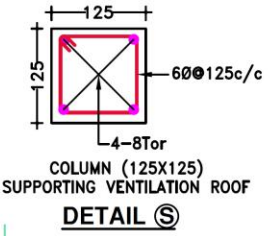

**DETAIL (S)**

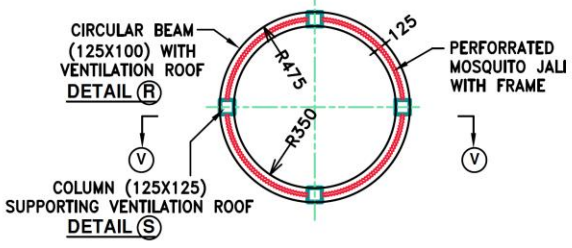

**PLAN SHOWING VENTILATION DUCT ON SECTION-C-C**

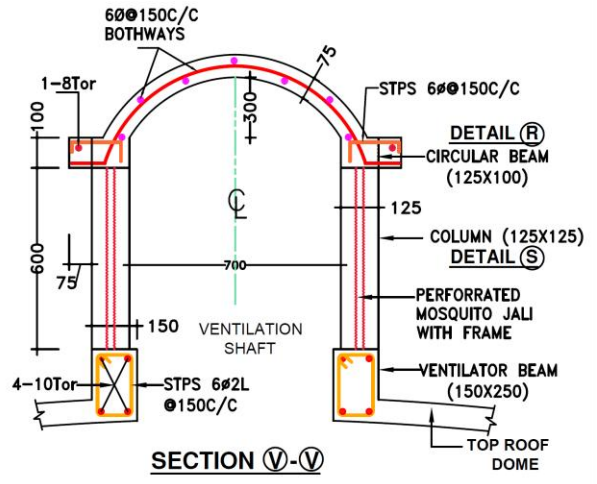

**SECTION V-V**

225 KL CAPACITY INTZE TYPE RCC WATER TOWER, STAZING 18M IN SEISMIC ZONE IV.

DRAWING No. **S-9**

TITLE **TOP ROOF DOME & VENTILATION**